

915 - 0.892 Kg/m

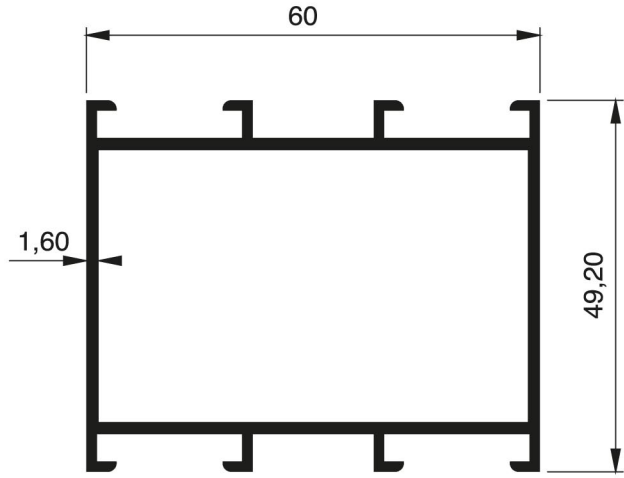

901 - 1.056 Kg/m

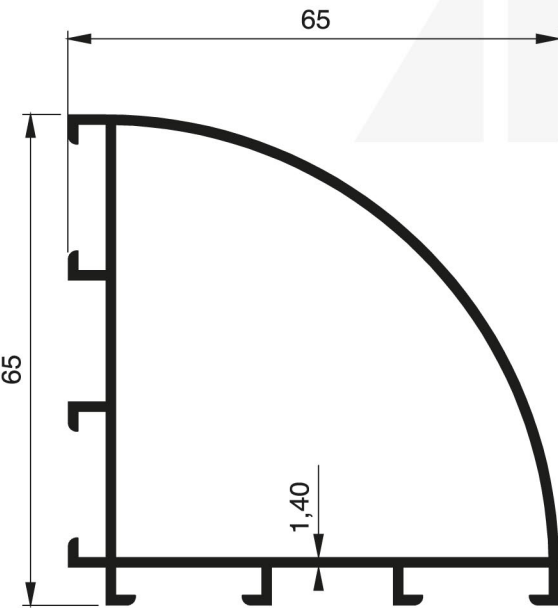

906 - 1.017 Kg/m

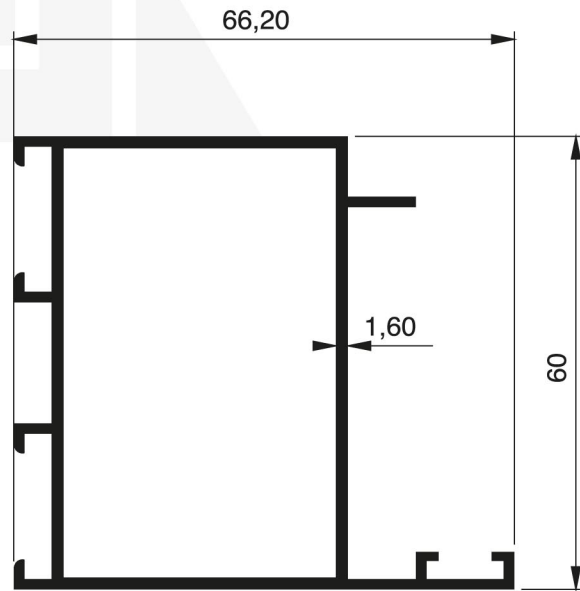

902 - 1.100 Kg/m

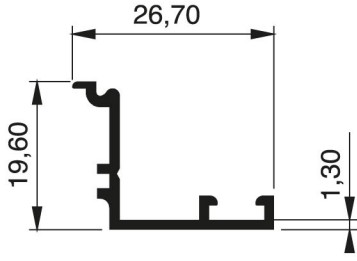

900 - 0.206 Kg/m

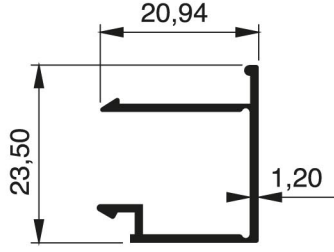

903 - 0.229 Kg/m

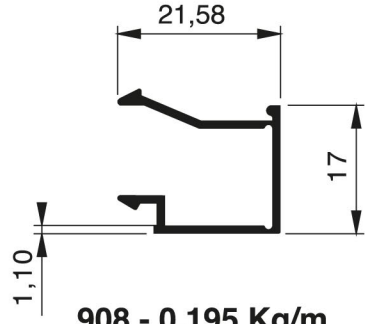

908 - 0.195 Kg/m

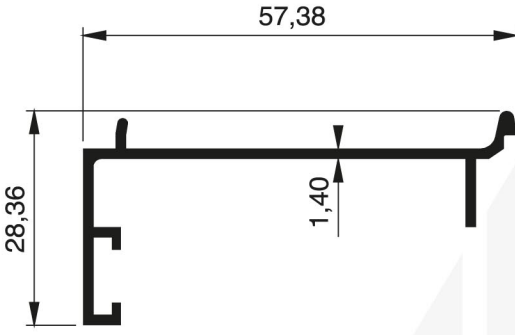

905 - 0.404 Kg/m

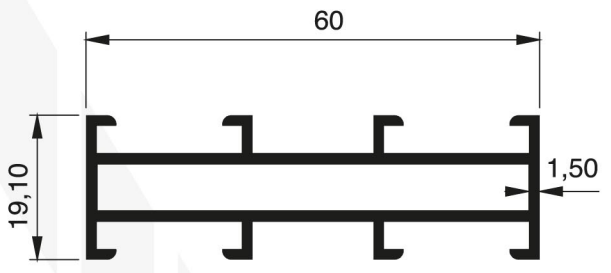

907 - 0.761 Kg/m

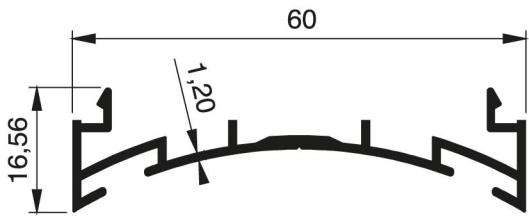

909 - 0.430 Kg/m

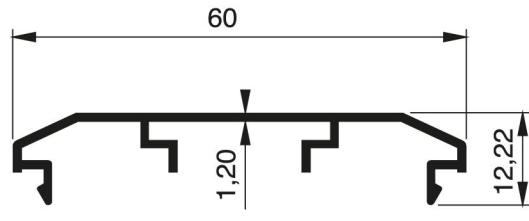

904 - 0.344 Kg/m