

UZUNER
ALÜMİNYUM

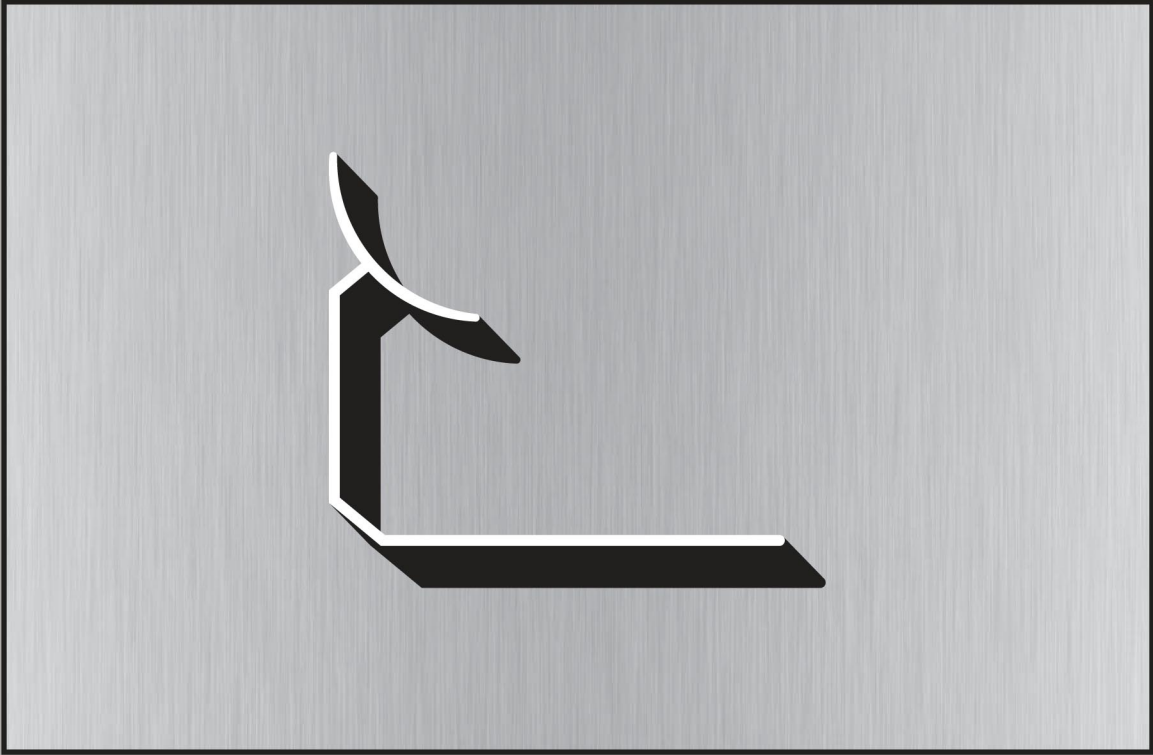

SERAMİK ve YER PROFİLLERİ
CERAMIC and FLOOR PROFILES

**2238- 0.061 Kg/m****2239- 0.064 Kg/m****2320- 0.104 Kg/m****2257- 0.103 Kg/m****2002- 0.122 Kg/m****2258- 0.121 Kg/m****2337 - 0.065 Kg/m****2003 - 0.108 Kg/m****2075- 0.112 Kg/m****2284 - 0.104 Kg/m****2240- 0.083 Kg/m****2321- 0.102 Kg/m**

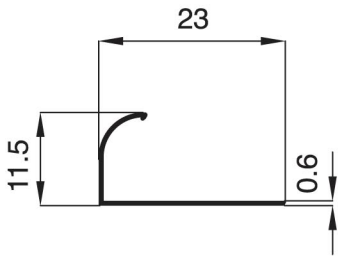
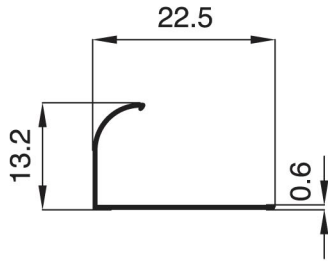
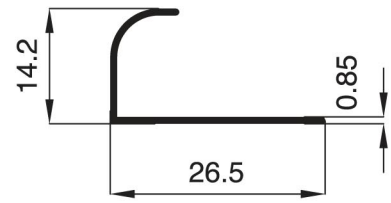
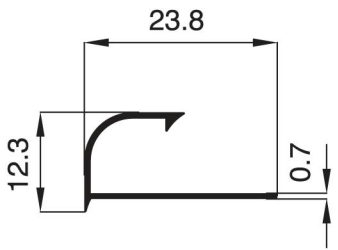
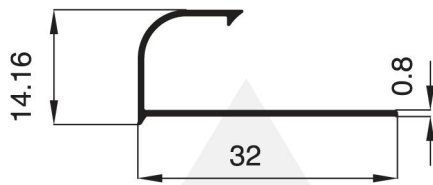
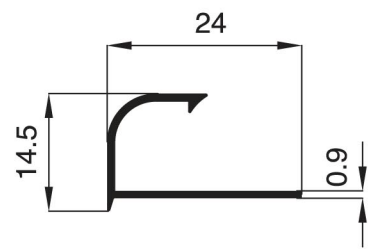
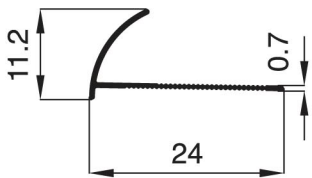
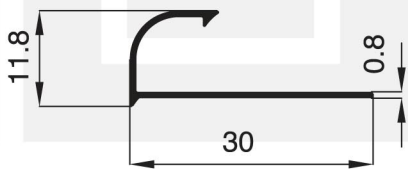
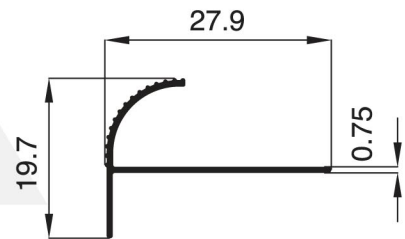
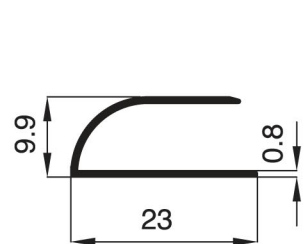
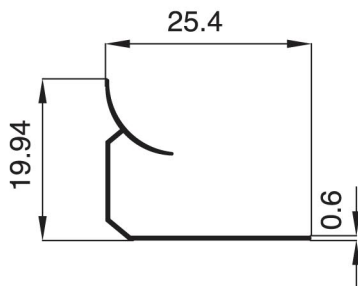
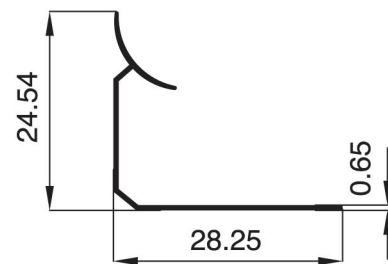
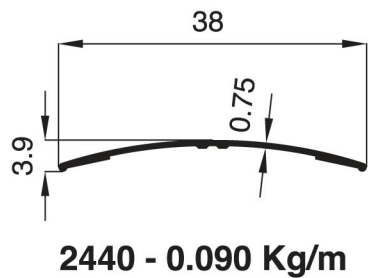
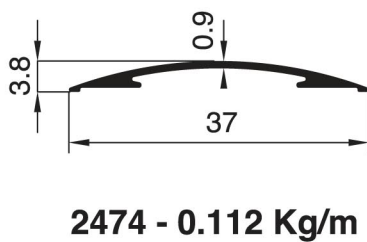
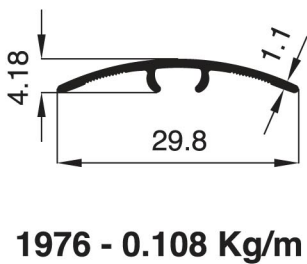
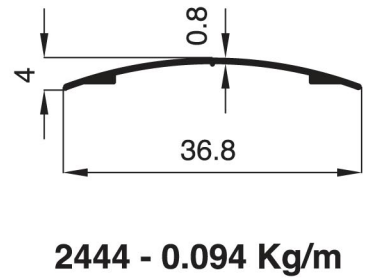
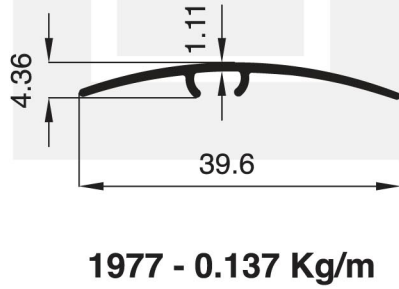
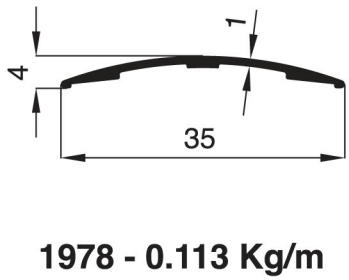
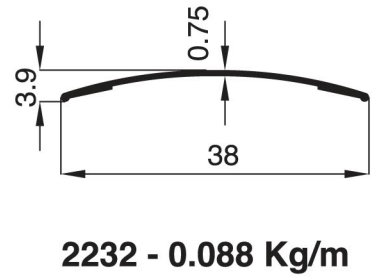
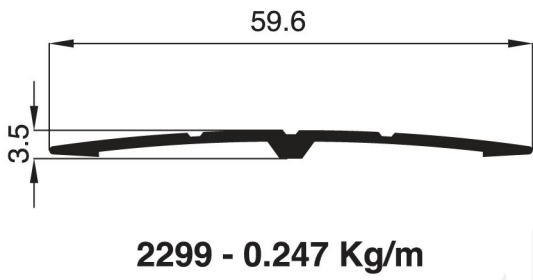
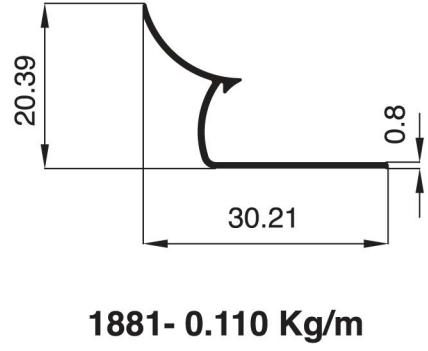
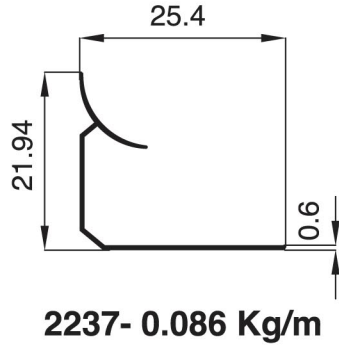
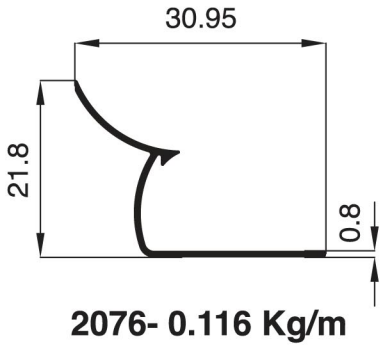

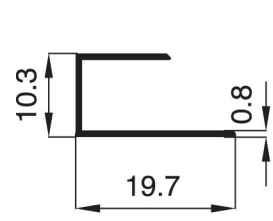

2256 - 0.087 Kg/m

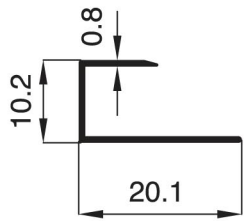

2445 - 0.082 Kg/m

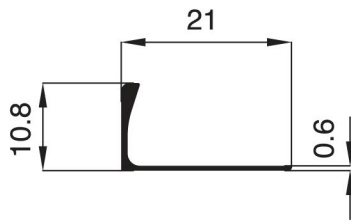

2286 - 0.068 Kg/m

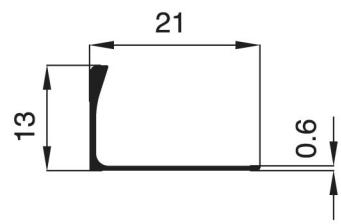

2288 - 0.073 Kg/m

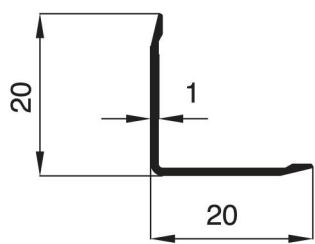

1882 - 0.102 Kg/m

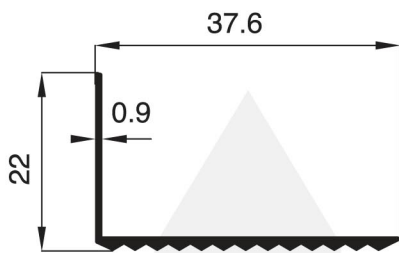

2231 - 0.190 Kg/m

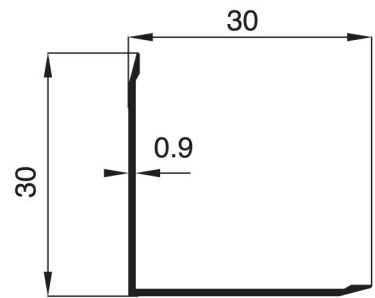

2077 - 0.141 Kg/m

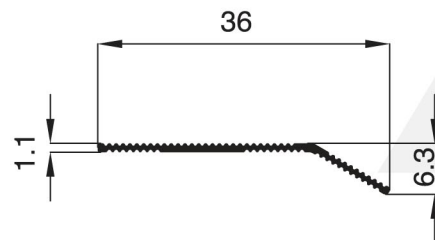

1936 - 0.089 Kg/m

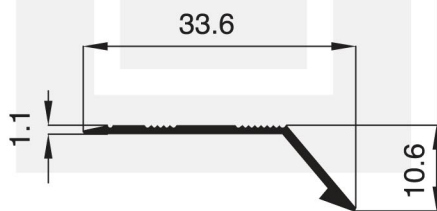

2273 - 0.112 Kg/m

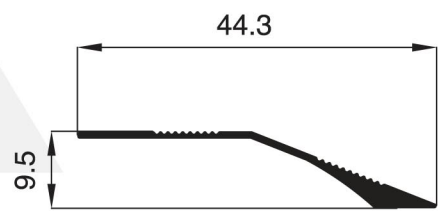

2255 - 0.150 Kg/m

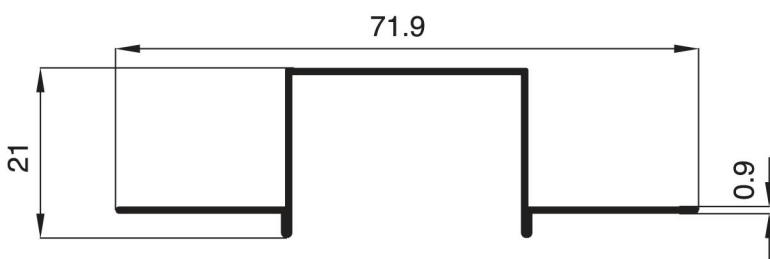

2074 - 0.280 Kg/m

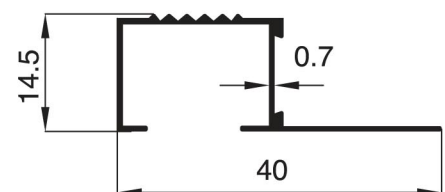

2336 - 0.158 Kg/m

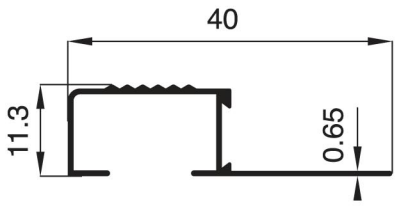

2285 - 0.143 Kg/m

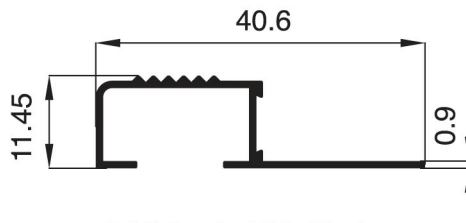

2024 - 0.181 Kg/m

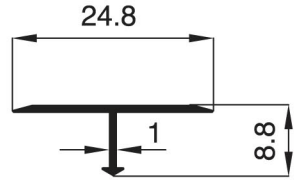

1982 - 0.087 Kg/m

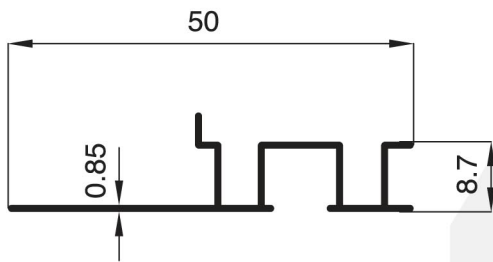

1979 - 0.212 Kg/m

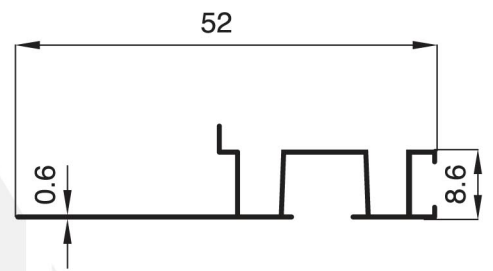

2289 - 0.160 Kg/m

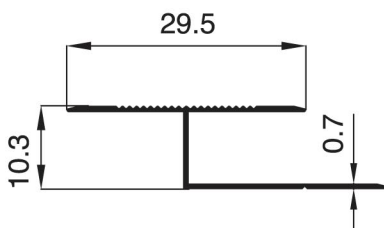

2287 - 0.120 Kg/m

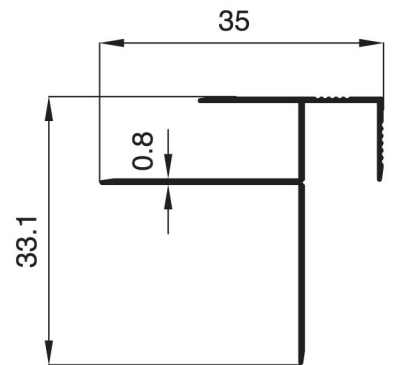

2290 - 0.190 Kg/m