

**UZUNER**  
**ALÜMİNYUM**

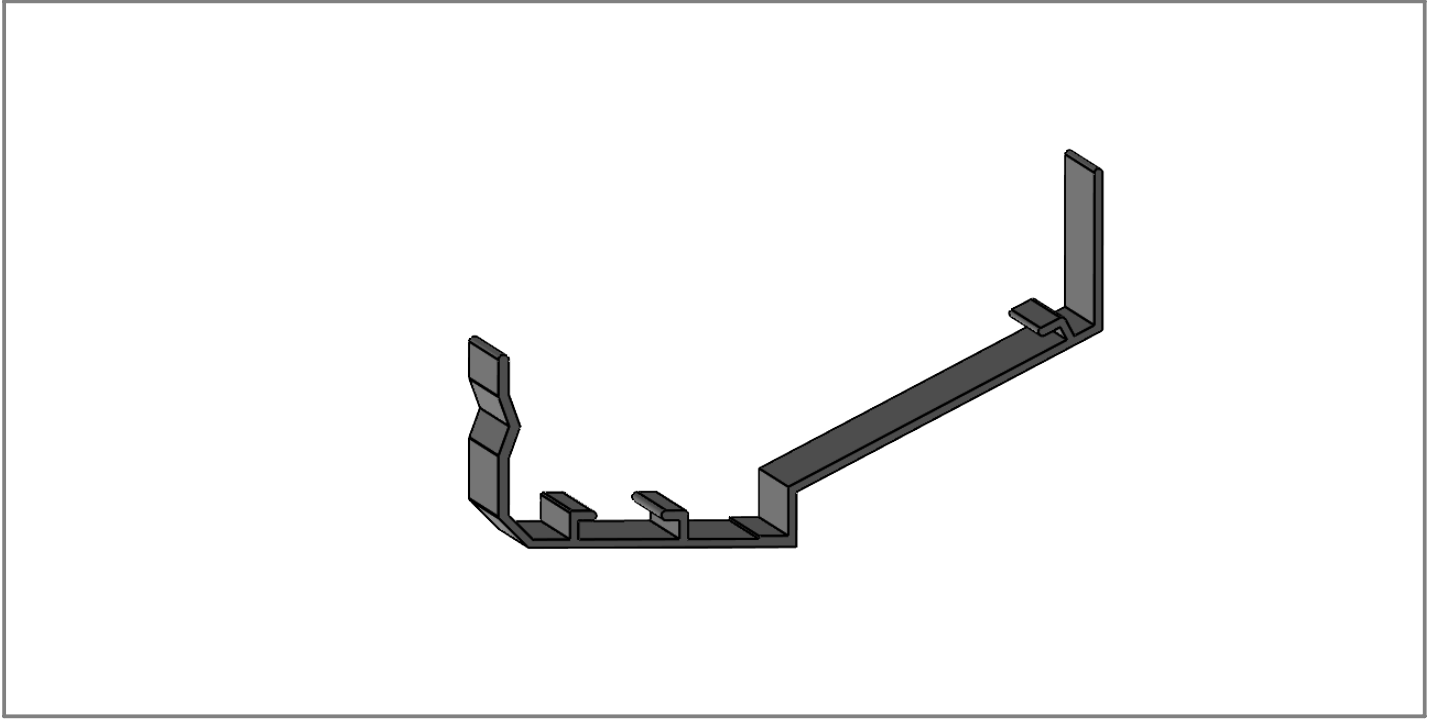

**Menfez Profilleri**  
**Culvert Profiles**

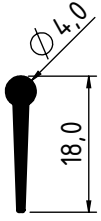

1277 - 0.093 Kg/m

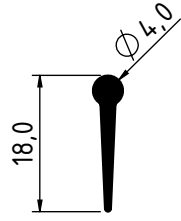

2225 - 0.087 Kg/m

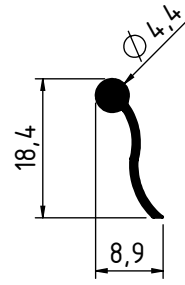

2068 - 0.087 Kg/m

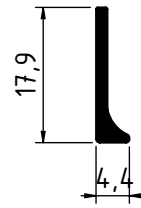

1876 - 0.090 Kg/m

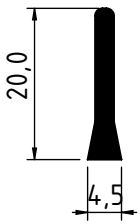

2119 - 0.150 Kg/m

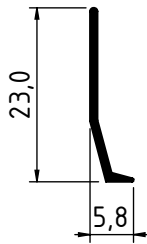

2046 - 0.071 Kg/m

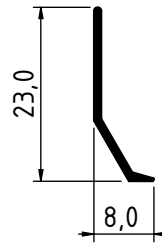

2228 - 0.071 Kg/m

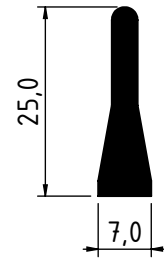

2230 - 0.296 Kg/m

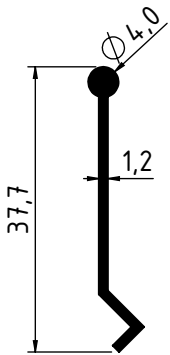

1946 - 0.155 Kg/m

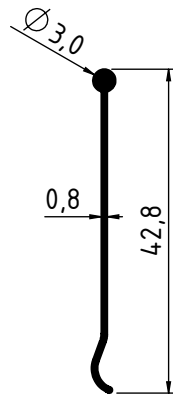

1984 - 0.109 Kg/m

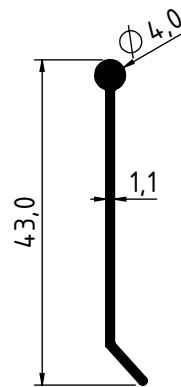

2548 - 0.158 Kg/m

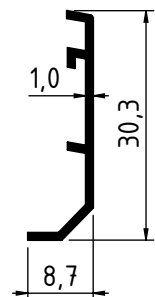

2211 - 0.122 Kg/m

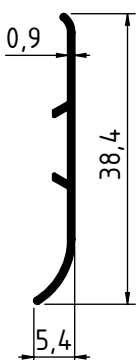

2374 - 0.112 Kg/m

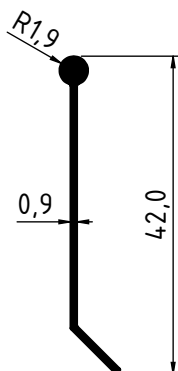

4552 - 0.129 Kg/m

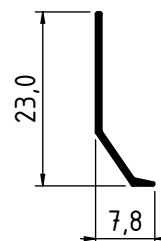

4551 - 0.057 Kg/m

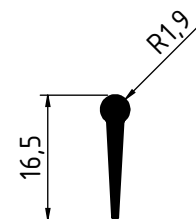

4550 - 0.065 Kg/m

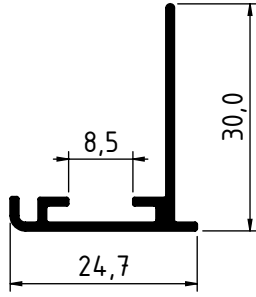

4554 - 0,207 Kg/m

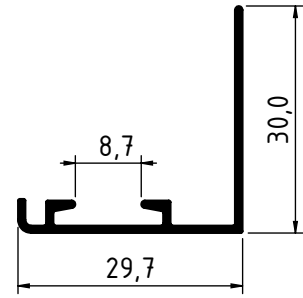

4555 - 0,203 Kg/m

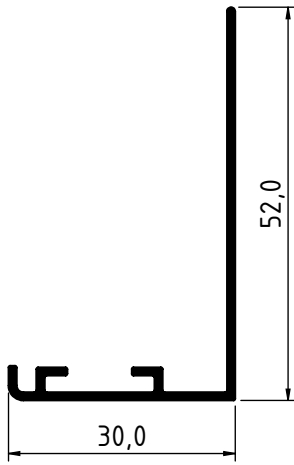

4556 - 0,287 Kg/m

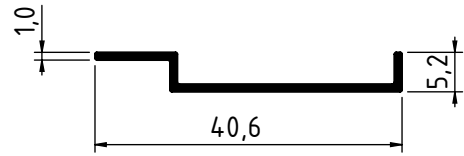

4557 - 0,133 Kg/m

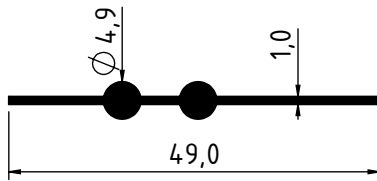

1210 - 0.209 Kg/m

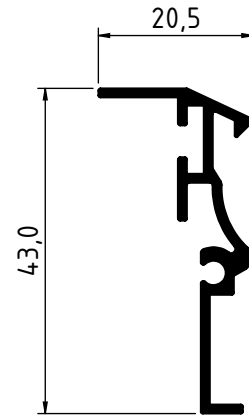

2366 - 0.320 Kg/m

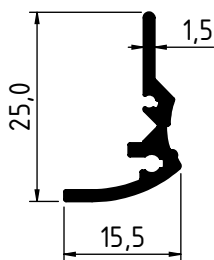

2659 - 0.193 Kg/m

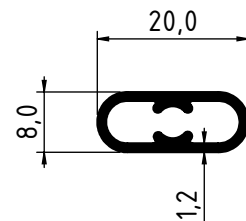

2226 - 0.179 Kg/m

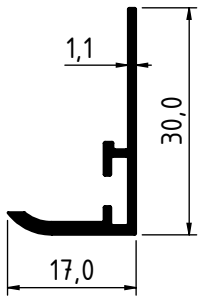

2542 - 0.185 Kg/m

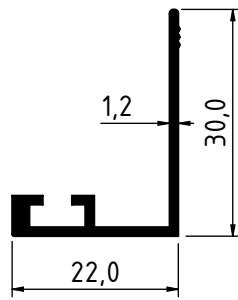

2118 - 0.217 Kg/m

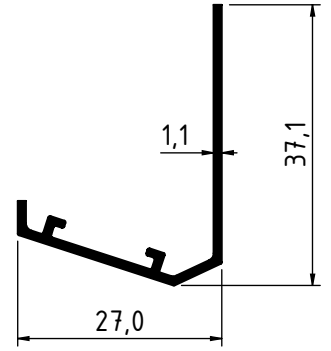

1939 - 0.220 Kg/m

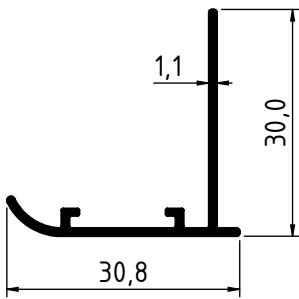

1812 - 0.206 Kg/m

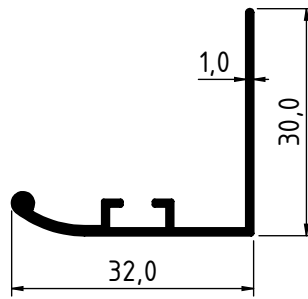

2507 - 0.220 Kg/m

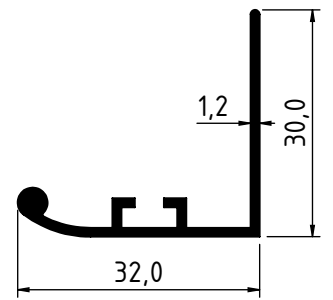

2048 - 0.326 Kg/m

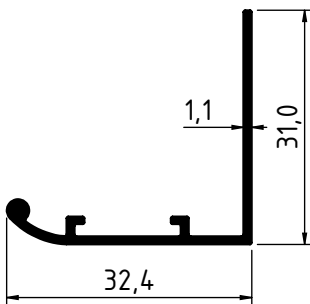

1813 - 0.225 Kg/m

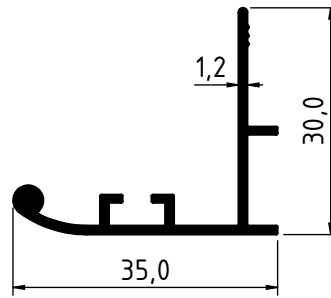

2596 - 0.285 Kg/m

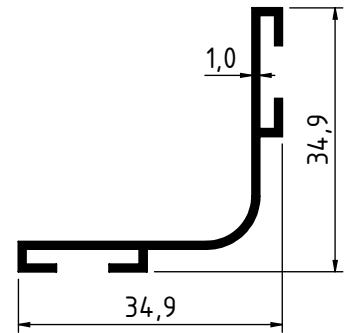

2212 - 0.242 Kg/m

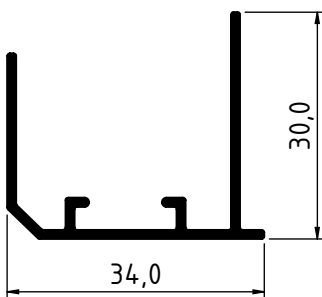

1845 - 0.315 Kg/m

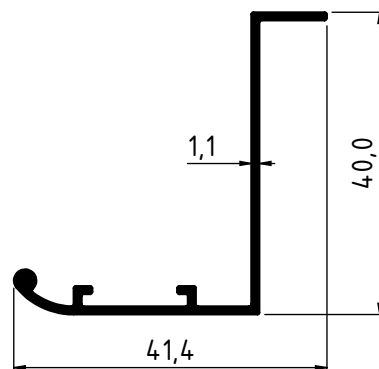

1817 - 0.282 Kg/m

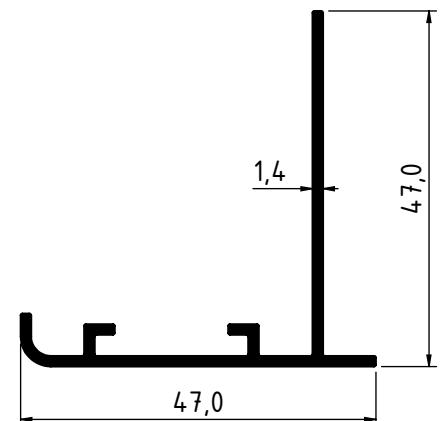

1208 - 0.421 Kg/m

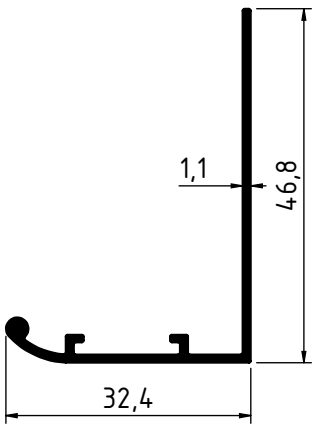

1846 - 0.273 Kg/m

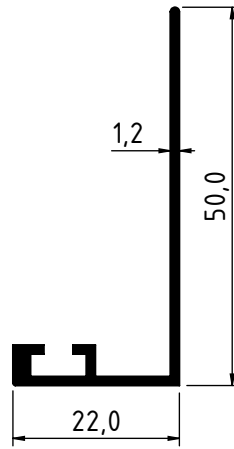

2047 - 0.280 Kg/m

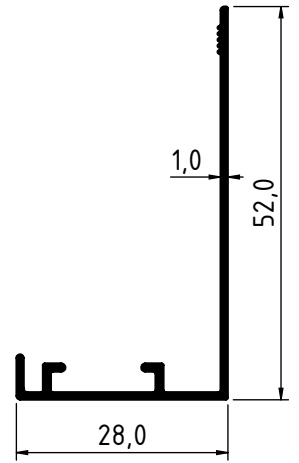

4356 - 0.263 Kg/m

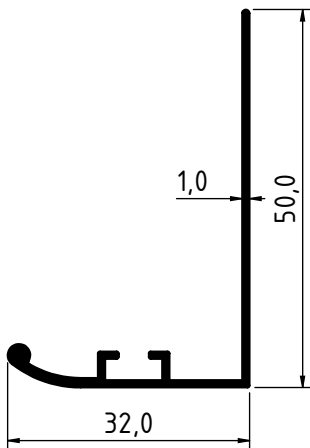

2508 - 0.274 Kg/m

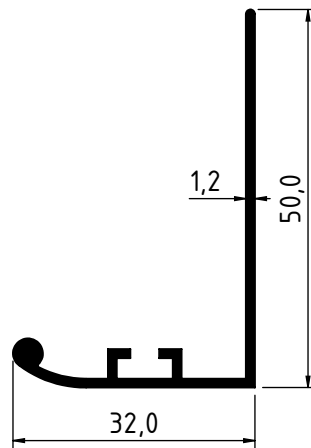

2049 - 0.326 Kg/m

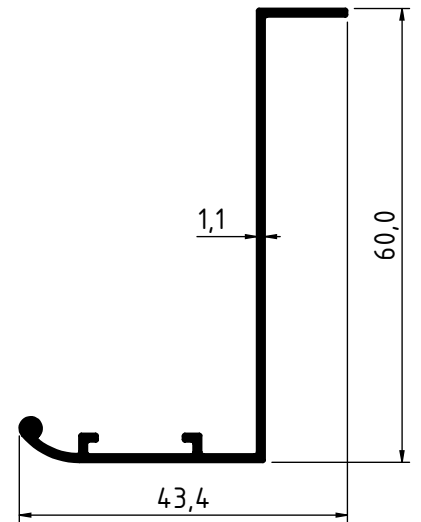

1945 - 0.347 Kg/m

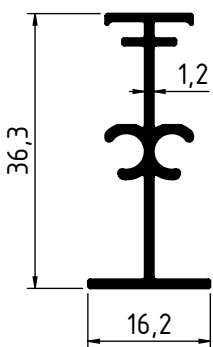

4260 - 0.280 Kg/m

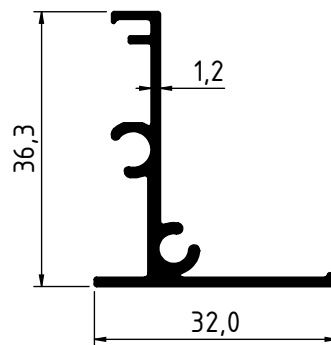

4259 - 0.332 Kg/m

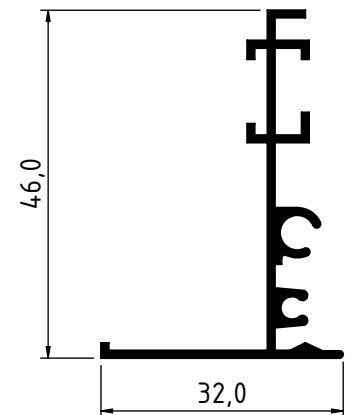

2066 - 0.366 Kg/m

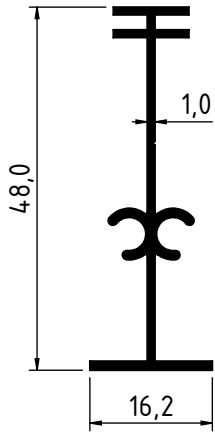

1815 - 0.293 Kg/m

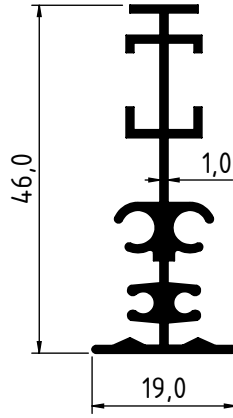

2067 - 0.437 Kg/m

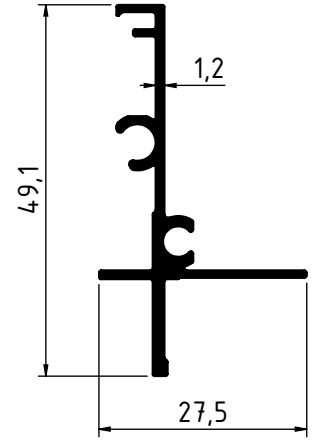

4298 - 0.352 Kg/m

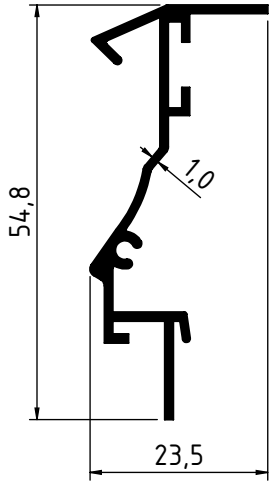

1916 - 0.366 Kg/m

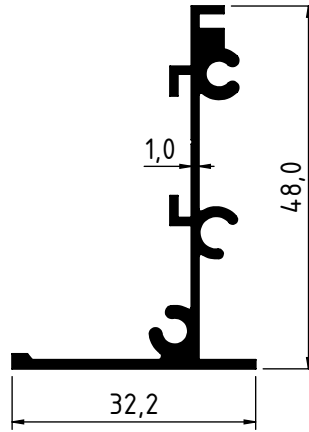

1814 - 0.442 Kg/m

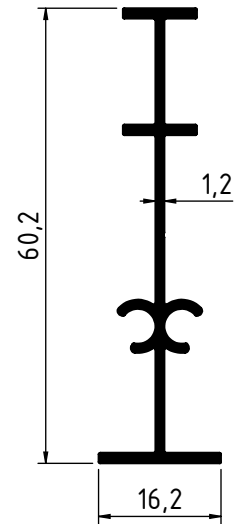

1849 - 0.380 Kg/m

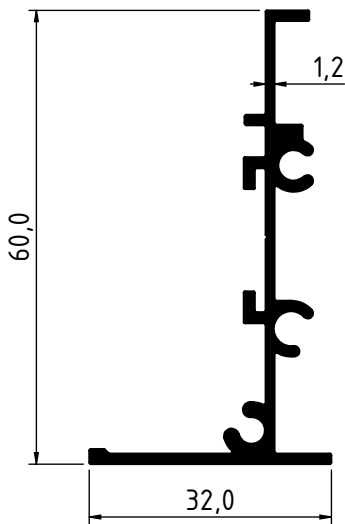

1850 - 0.542 Kg/m

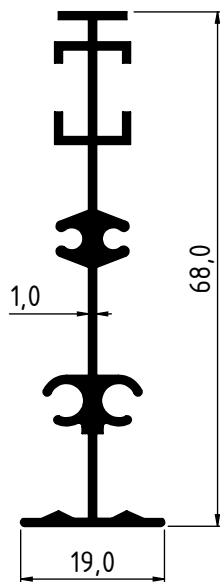

2312 - 0.524 Kg/m

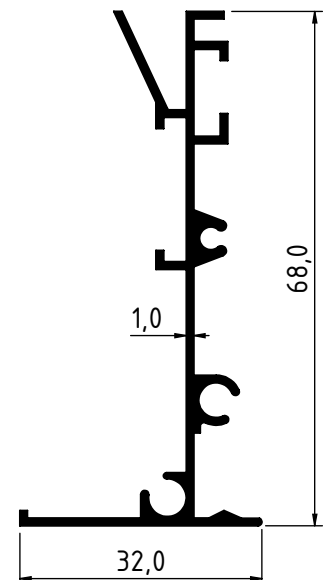

2311 - 0.515 Kg/m

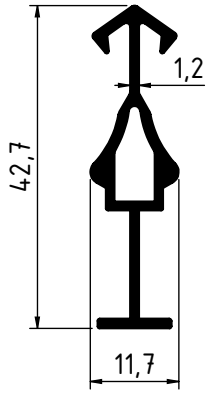

2179 - 0.331 Kg/m

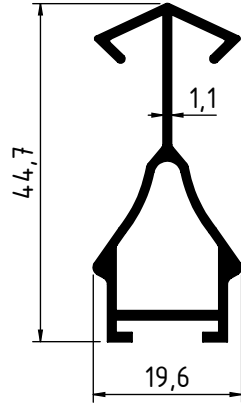

1915 - 0.385 Kg/m

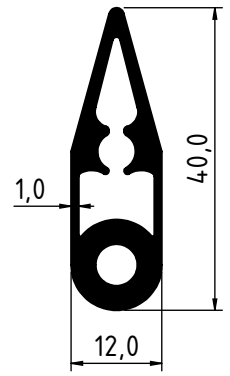

2404 - 0.561 Kg/m

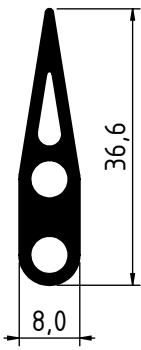

2391 - 0.396 Kg/m

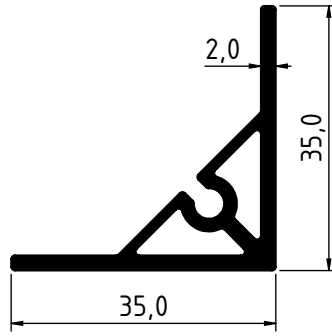

2490 - 0.545 Kg/m

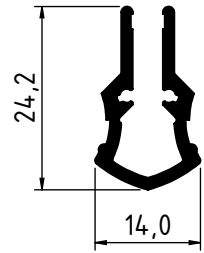

1997 - 0.261 Kg/m

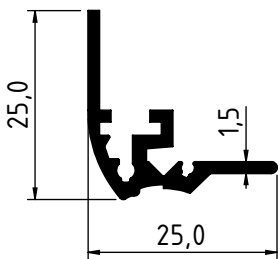

1996 - 0.282 Kg/m

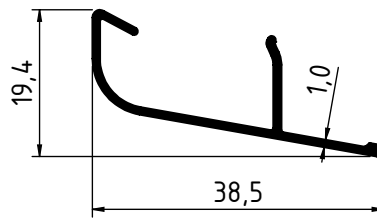

1827 - 0.190 Kg/m

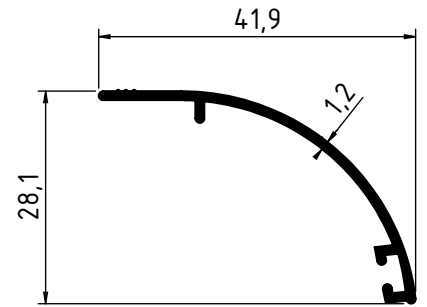

2194 - 0.215 Kg/m

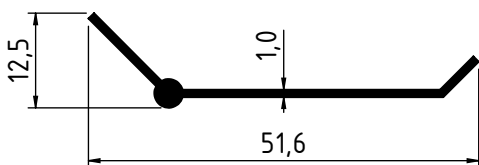

2219 - 0.177 Kg/m

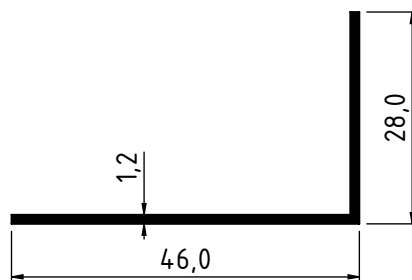

2070 - 0.239 Kg/m

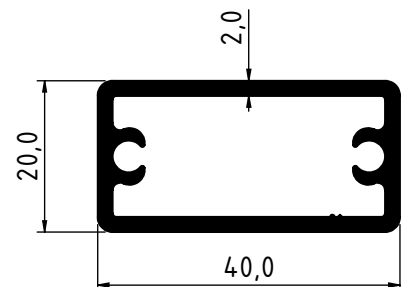

1859 - 0.686 Kg/m

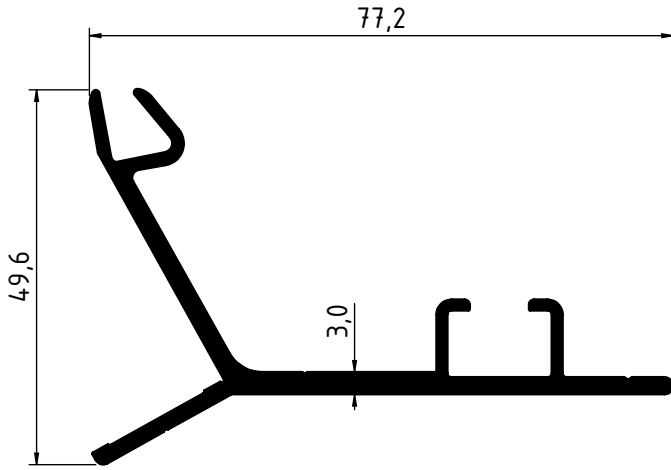

1854 - 0.963 Kg/m

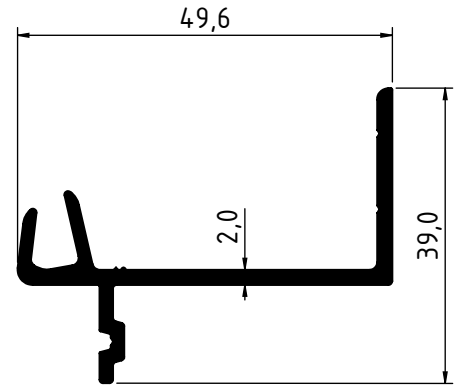

1858 - 0.559 Kg/m

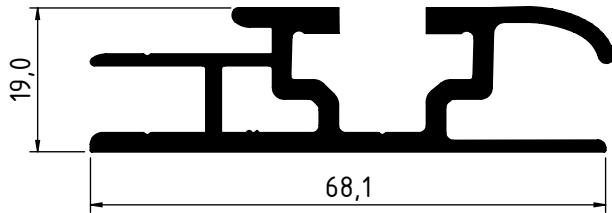

1855 - 1.085 Kg/m

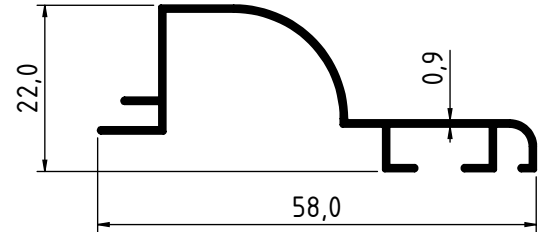

2375 - 0.277 Kg/m

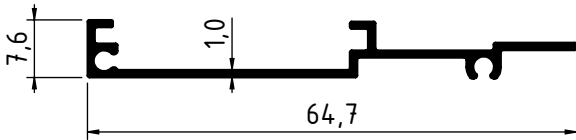

1211 - 0.255 Kg/m

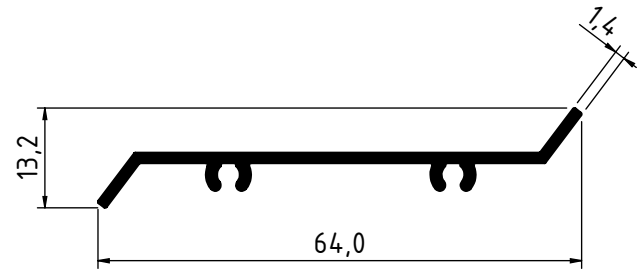

1209 - 0.326 Kg/m

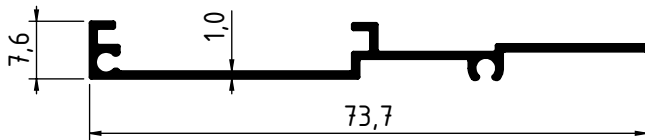

2477 - 0.280 Kg/m

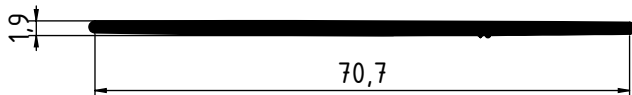

1862 - 0.345 Kg/m

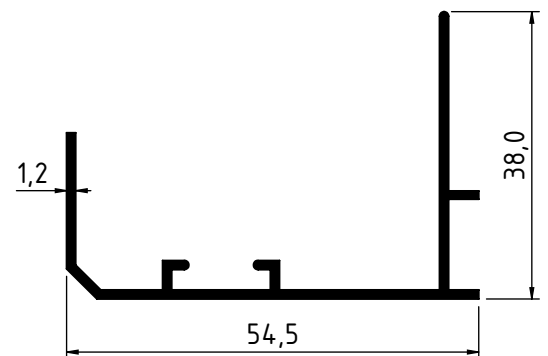

2315 - 0.410 Kg/m



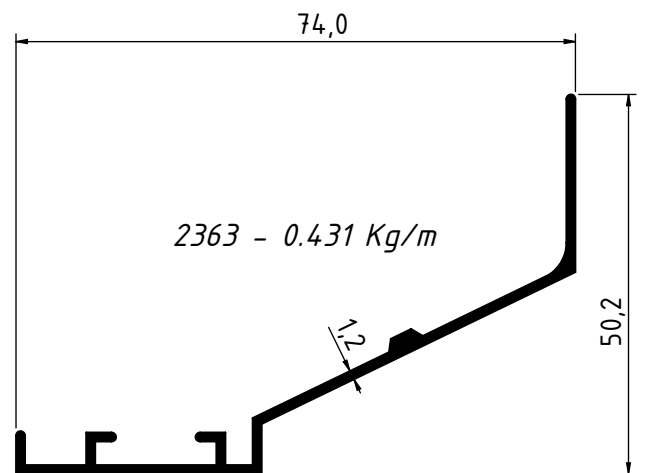
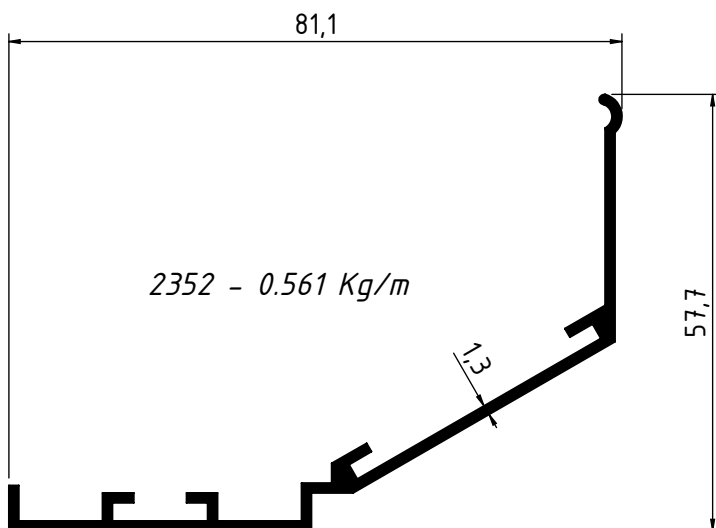
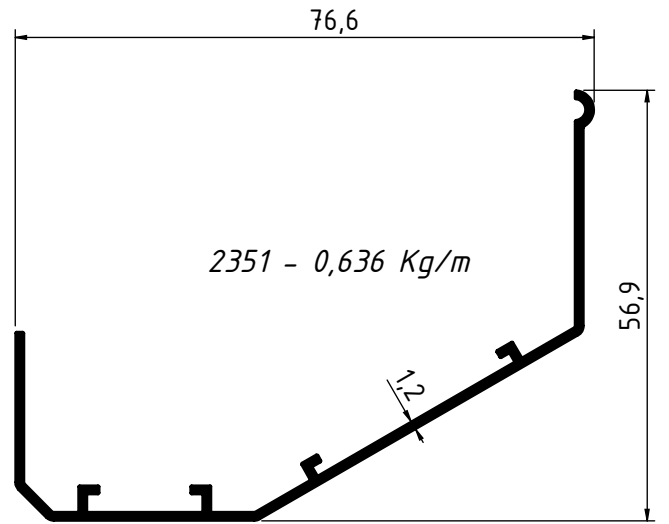
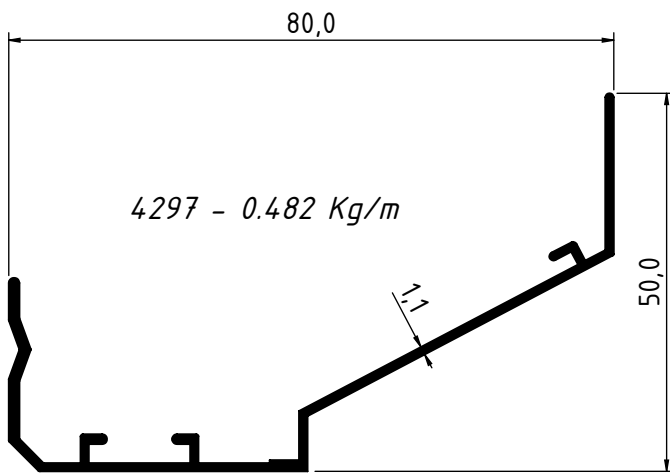
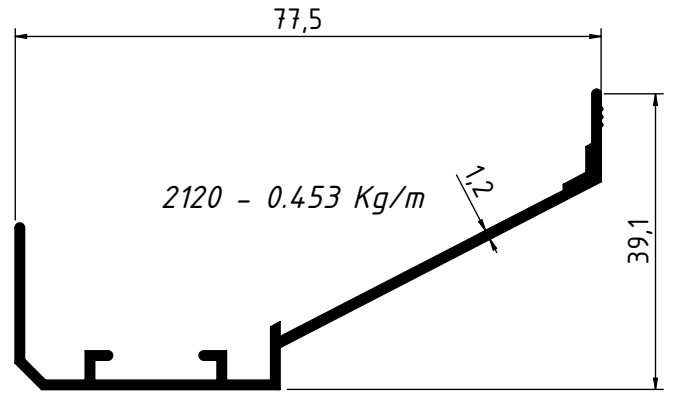
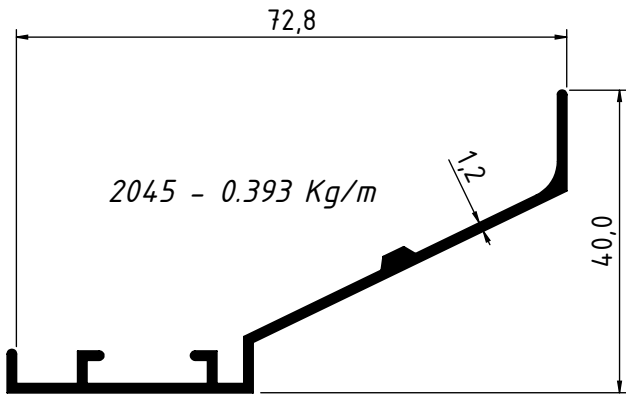

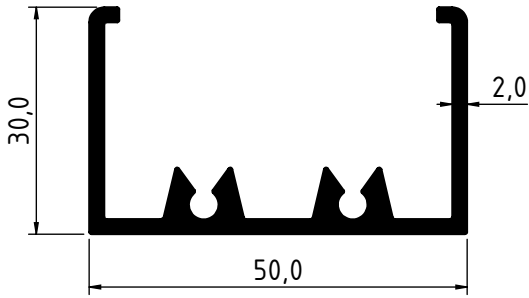

1267 - 0.789 Kg/m

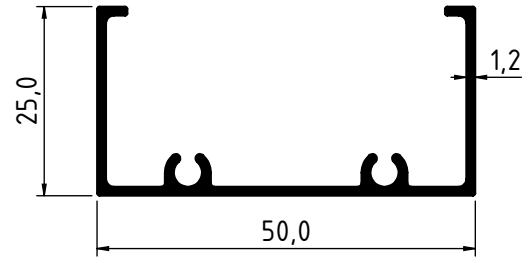

2213 - 0.407 Kg/m

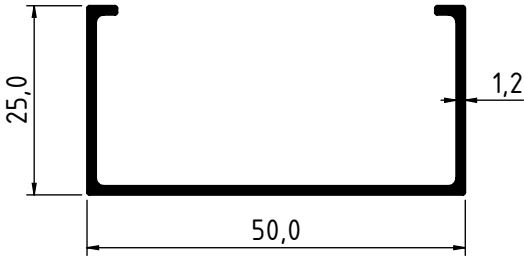

2214 - 0.339 Kg/m

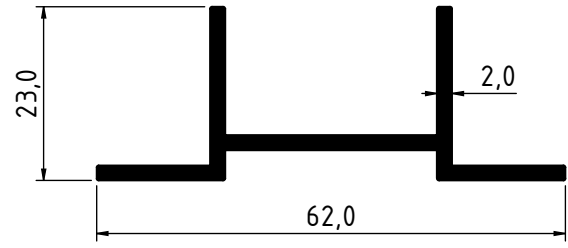

2401 - 0.564 Kg/m

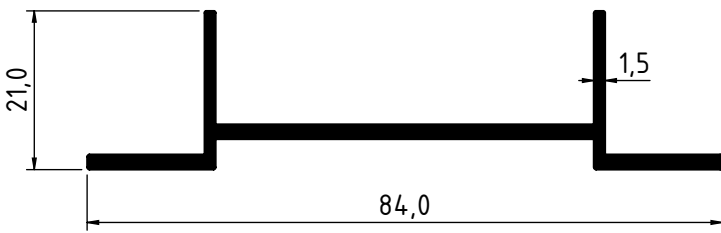

2402 - 0.610 Kg/m

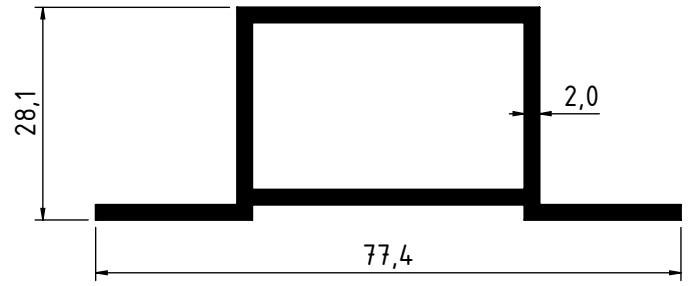

2250 - 0.900 Kg/m

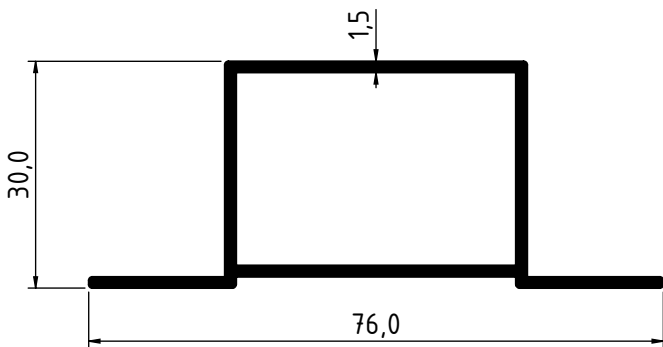

2550 - 0.692 Kg/m

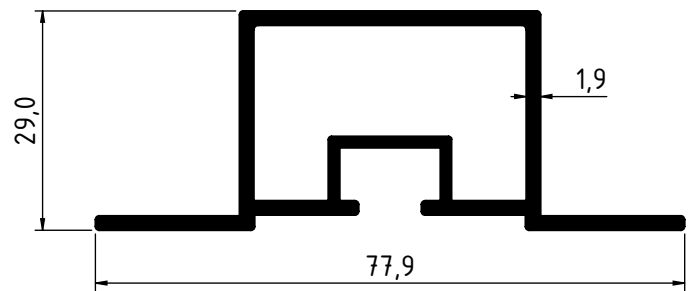

2811 - 0.946 Kg/m

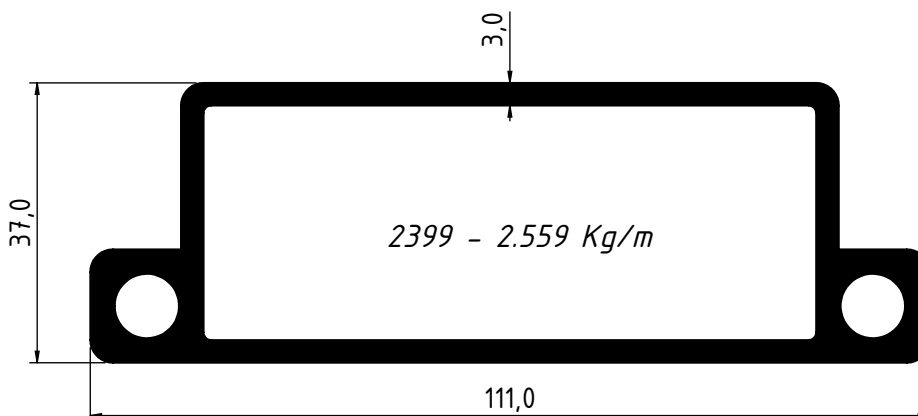
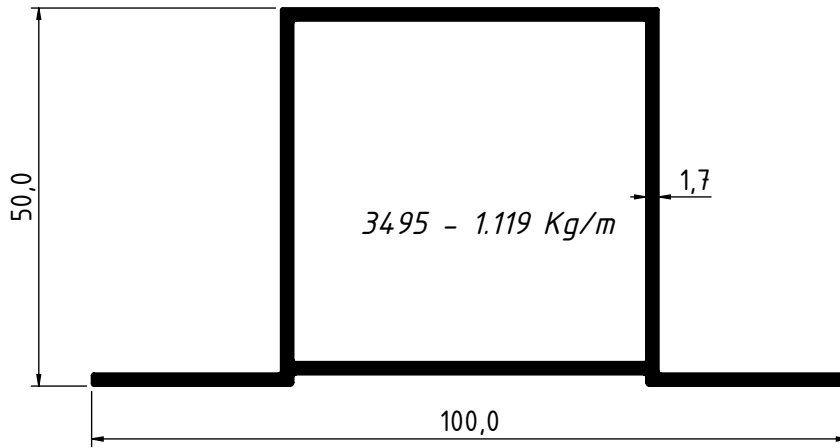
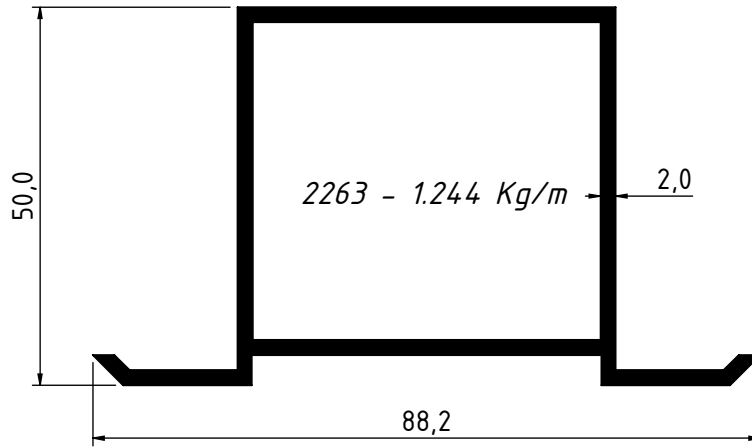
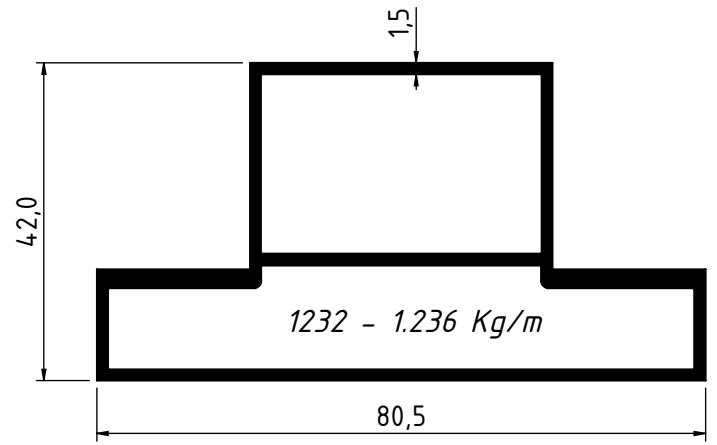
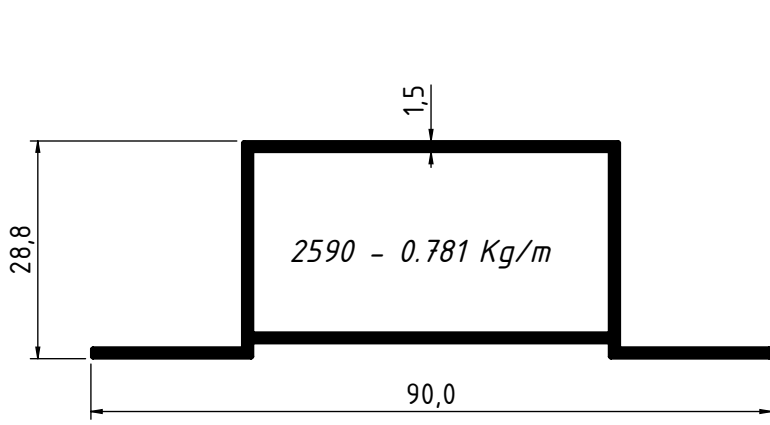

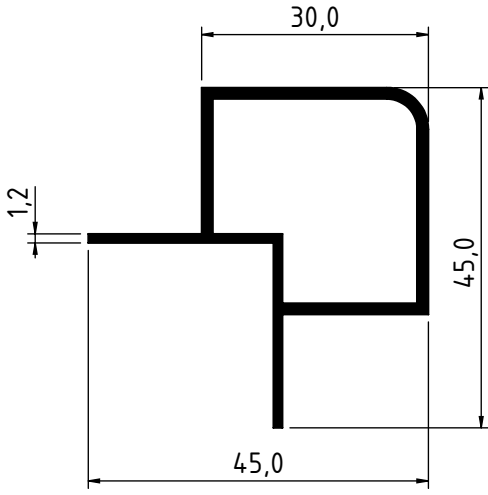

2248 - 0.540 Kg/m

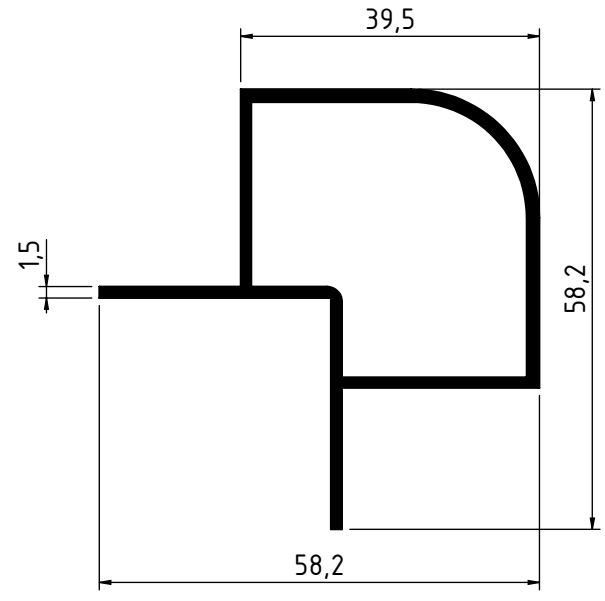

2249 - 0.765 Kg/m

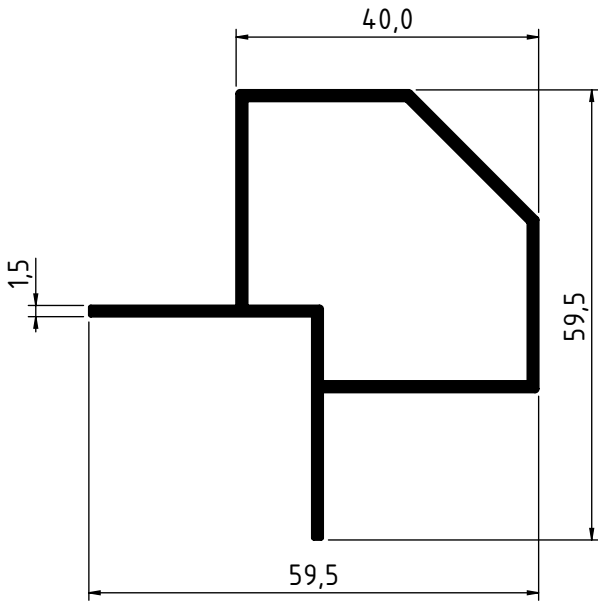

2549 - 0.746 Kg/m

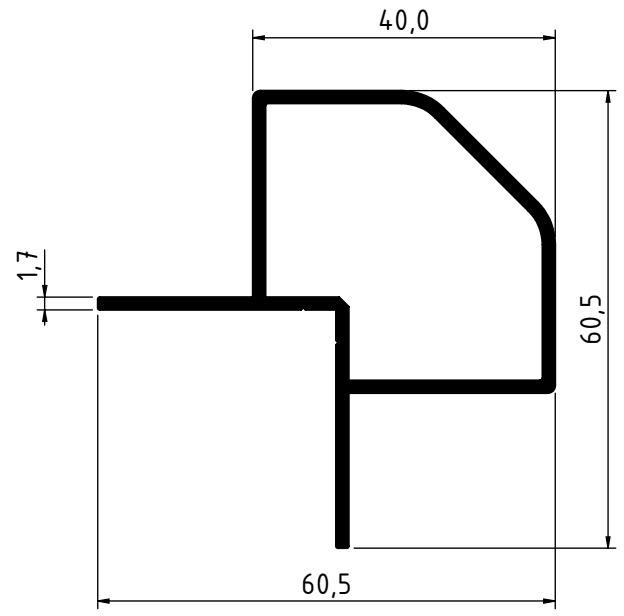

2812 - 0.845 Kg/m

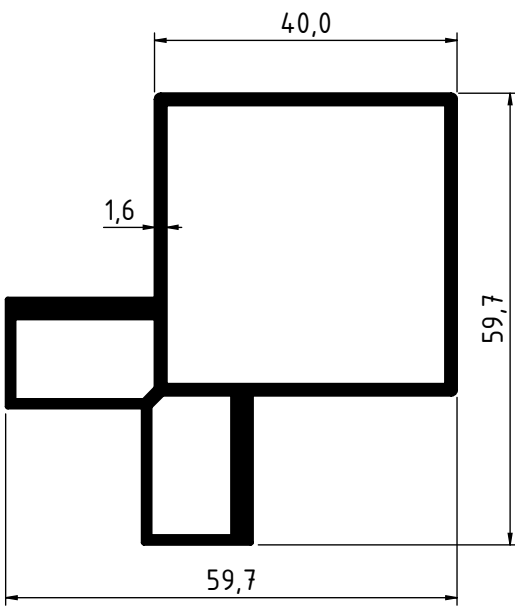

1231 - 1.187 Kg/m

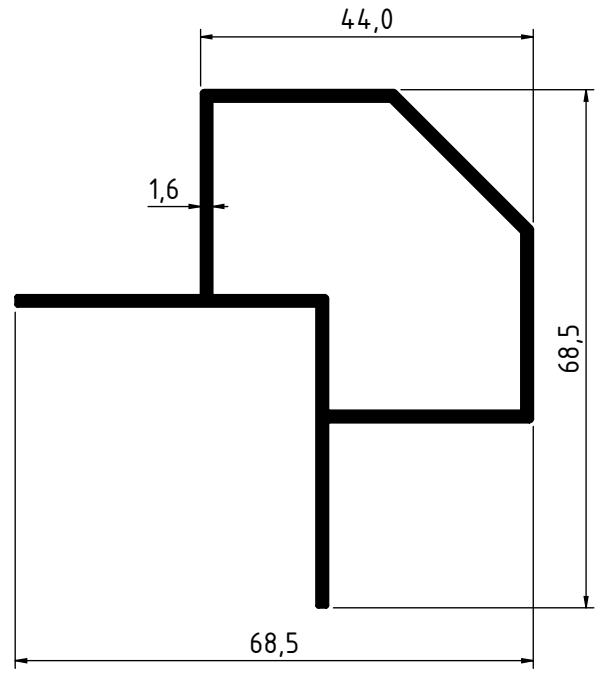

2362 - 0.903 Kg/m

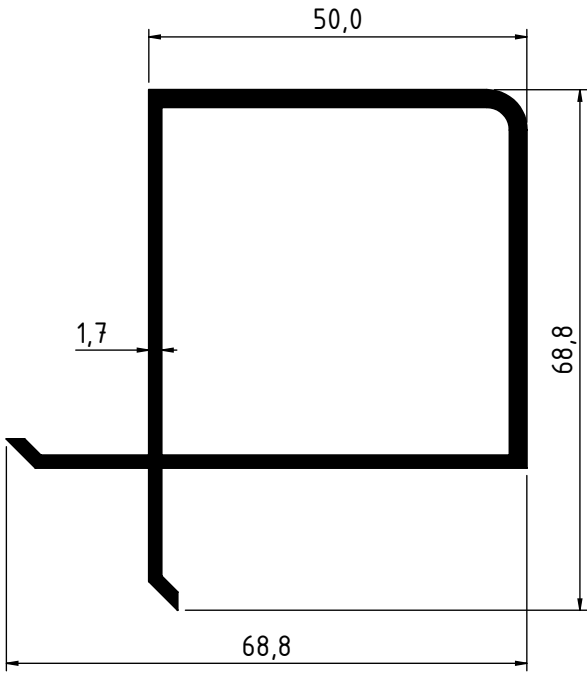

2264 - 1.206 Kg/m

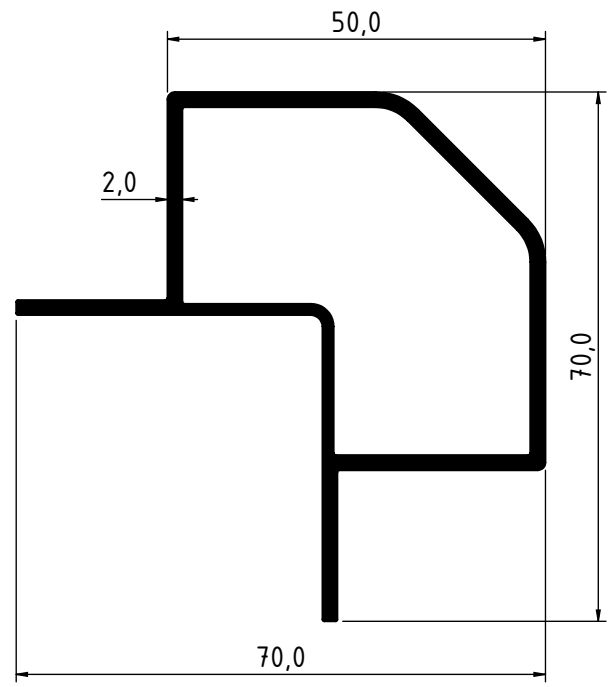

2265 - 1.136 Kg/m

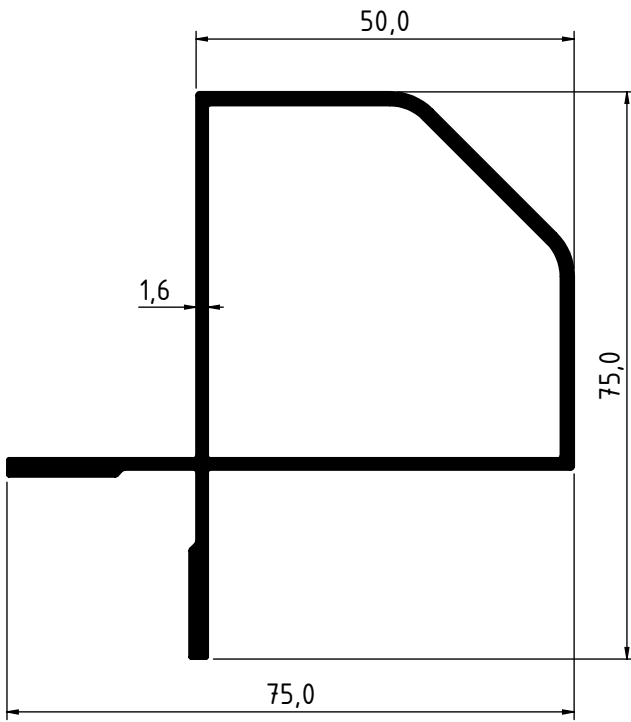

3494 - 1.119 Kg/m

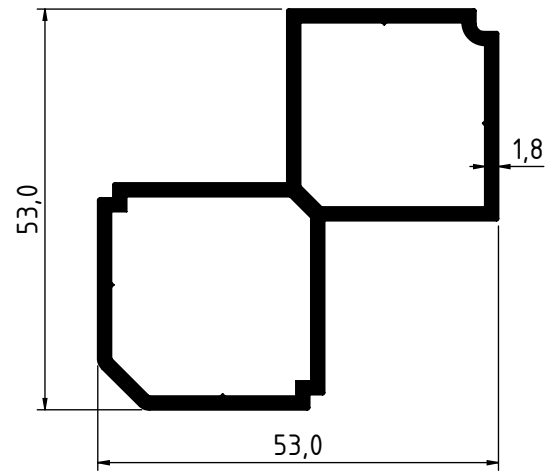

1947 - 0.998 Kg/m

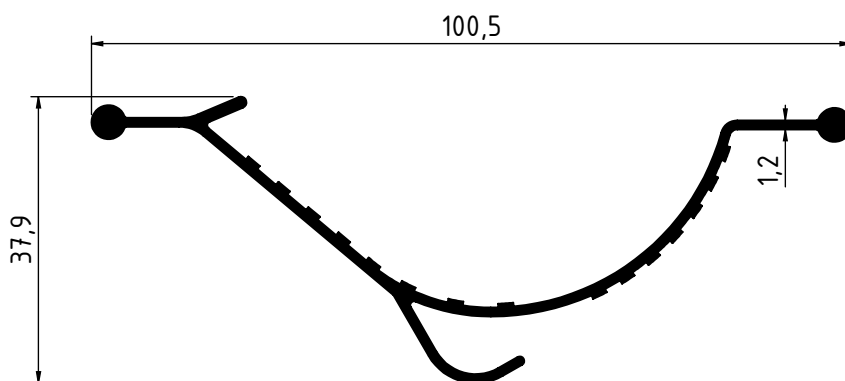

2227 - 0.597 Kg/m

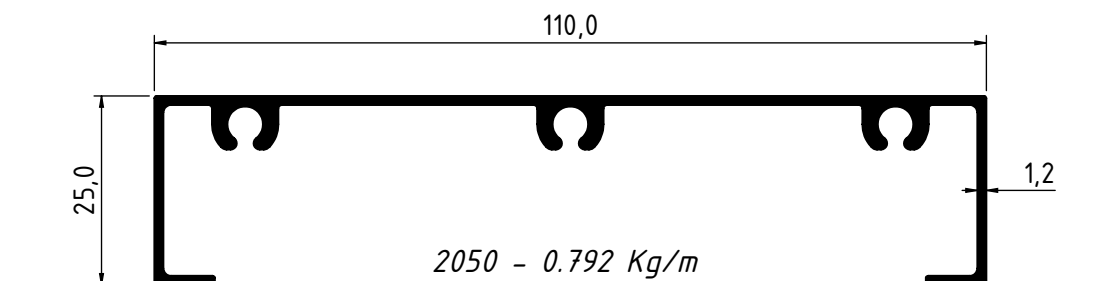
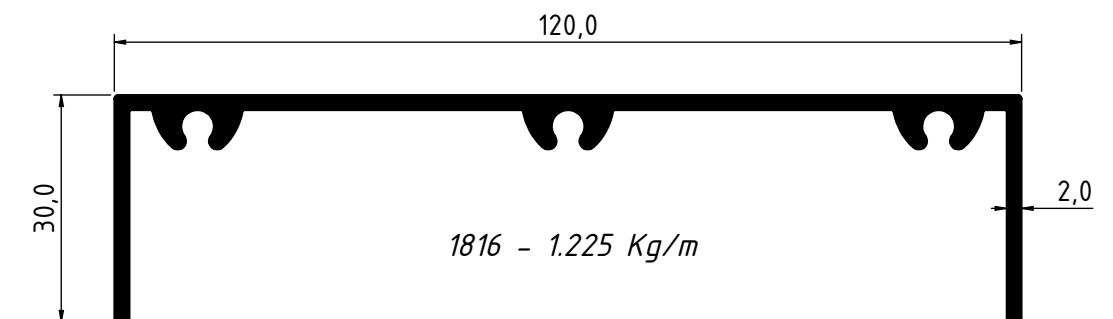
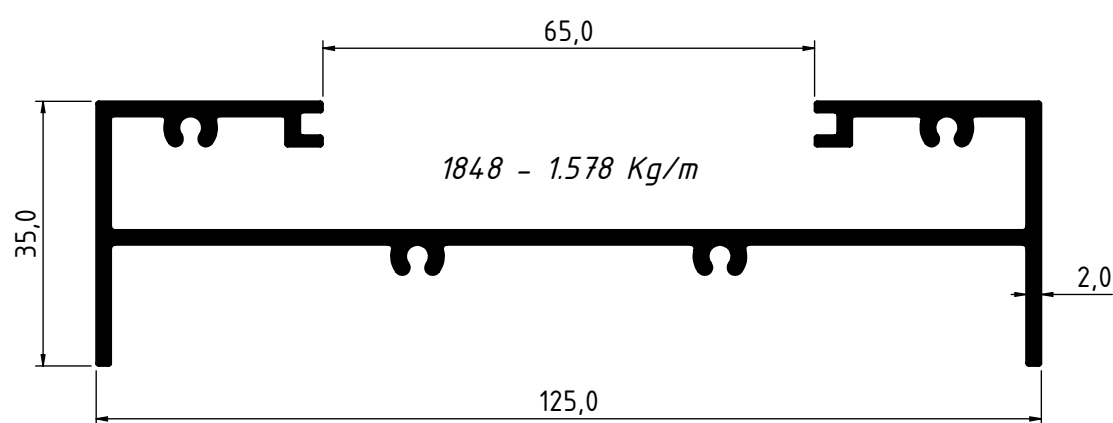
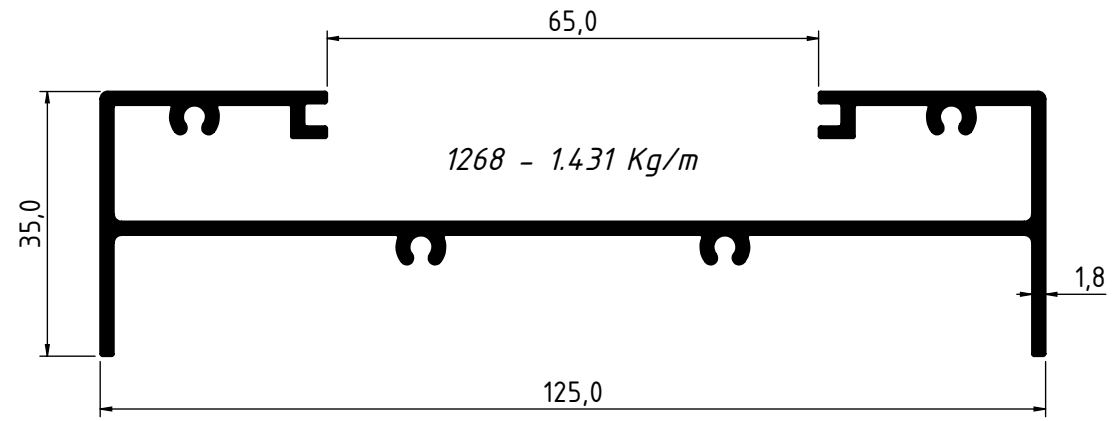
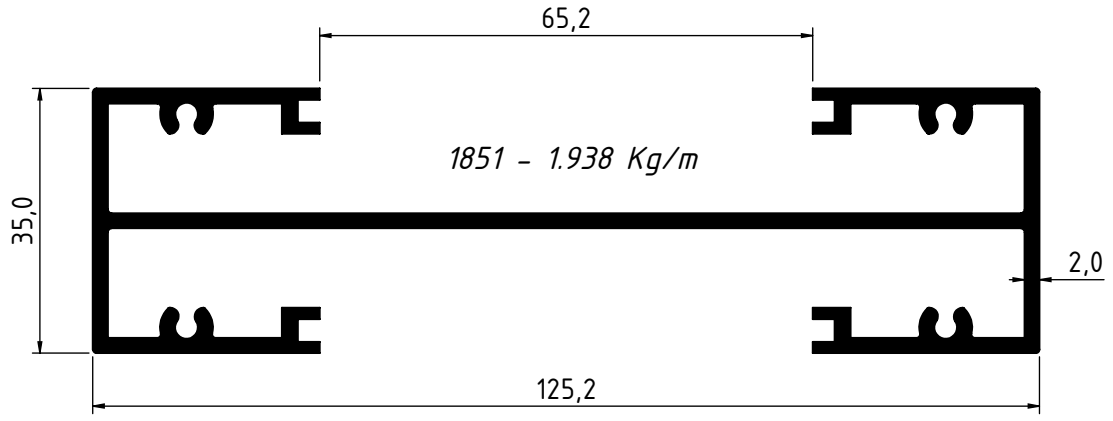

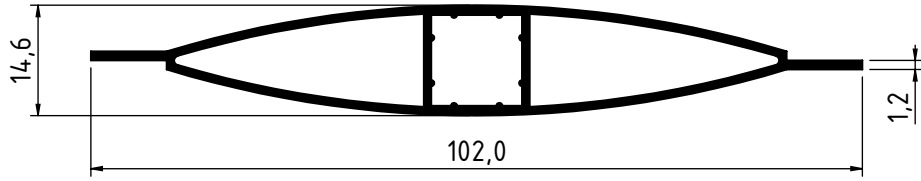

2051 - 0.610 Kg/m

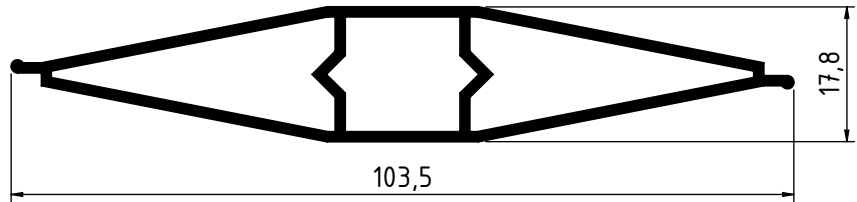

1818 - 0.841 Kg/m

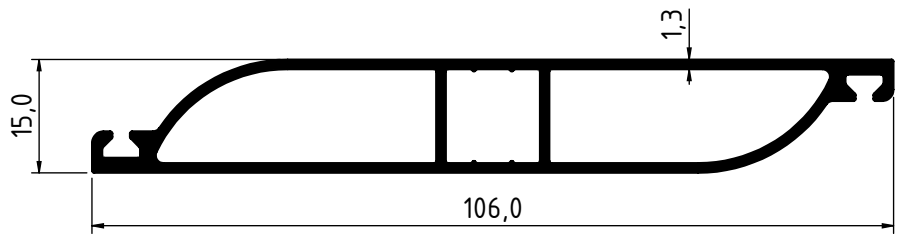

1265 - 0.925 Kg/m

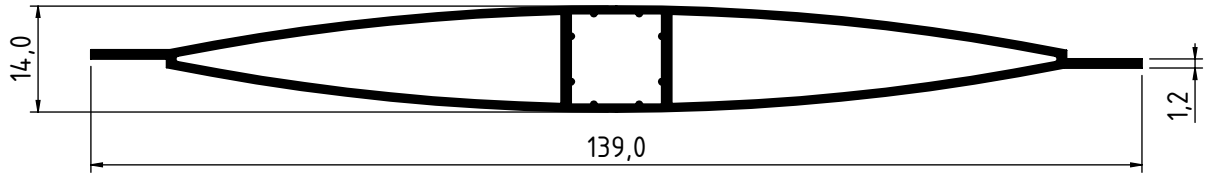

2071 - 0.805 Kg/m

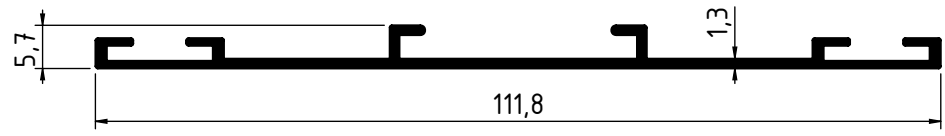

2377 - 0.507 Kg/m

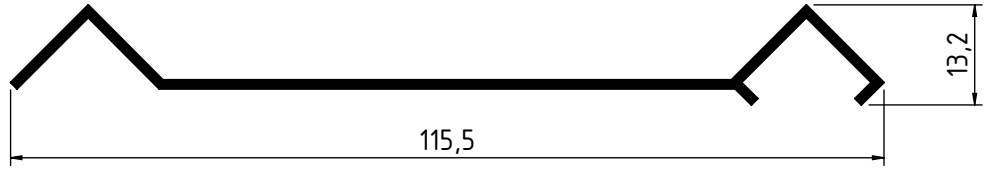

2196 - 0.448 Kg/m

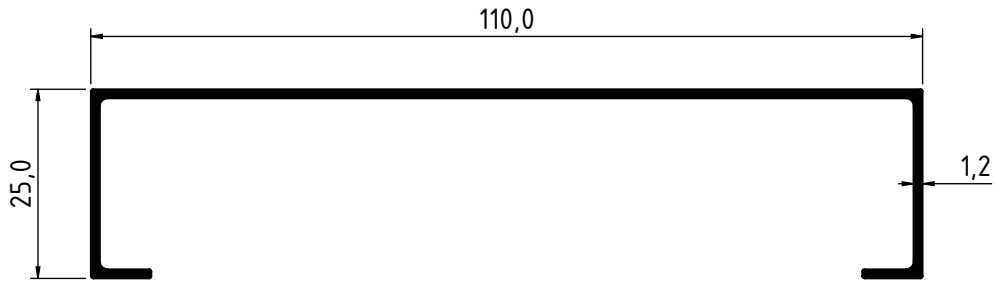

2044 - 0.561 Kg/m

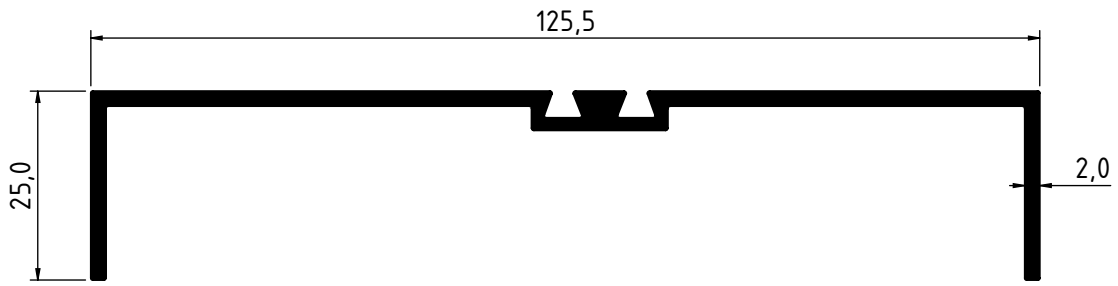

1847 - 1.011 Kg/m

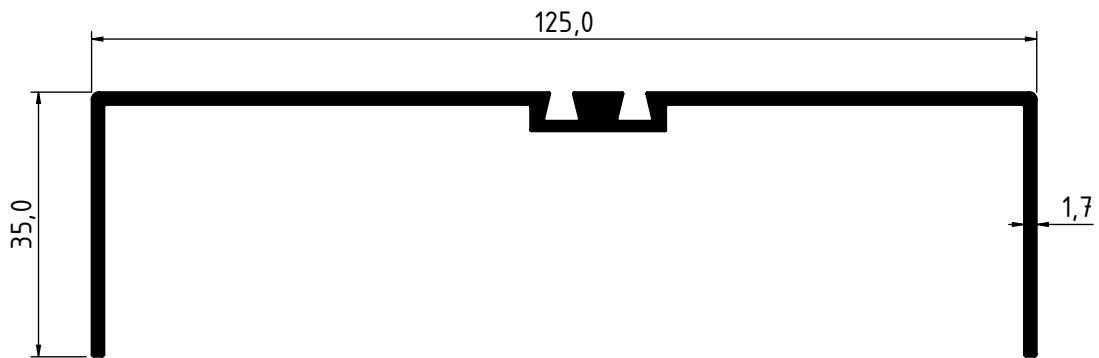

1269 - 0.976 Kg/m

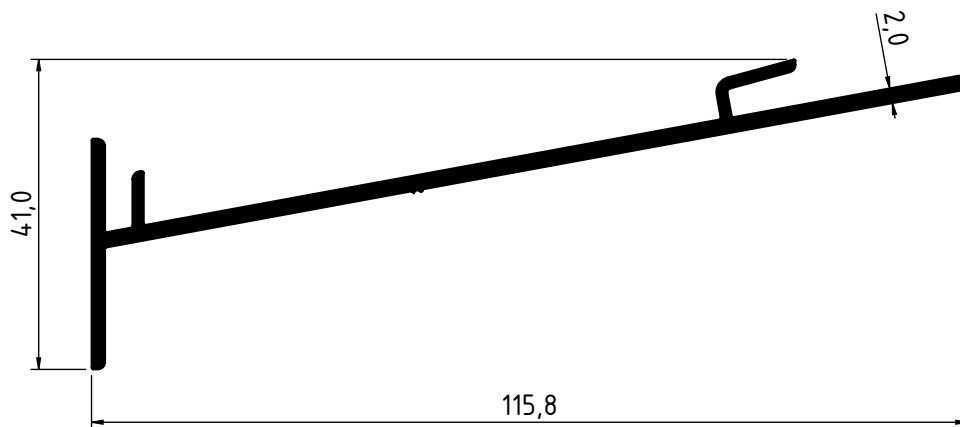

1856 - 0.865 Kg/m