

UZUNER
ALÜMİNYUM

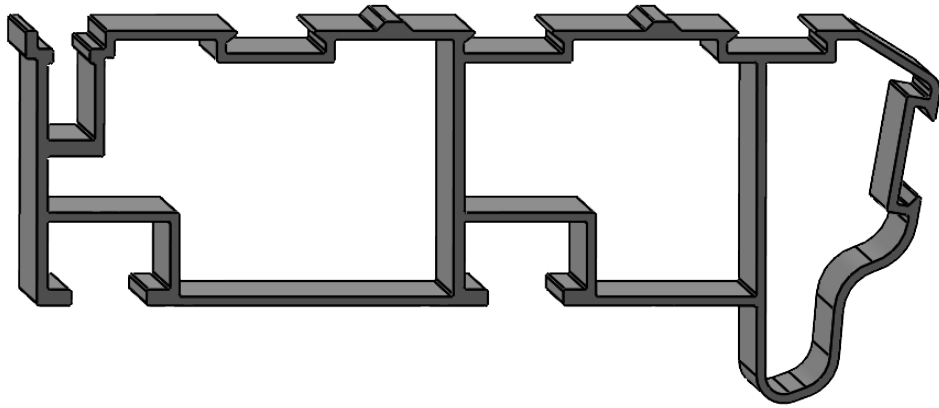

Otomotiv & Karoser Profilleri
Automotive & Karoser Profiles

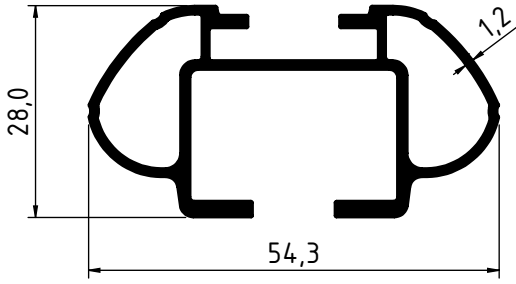

4303 - 0.698 Kg/m

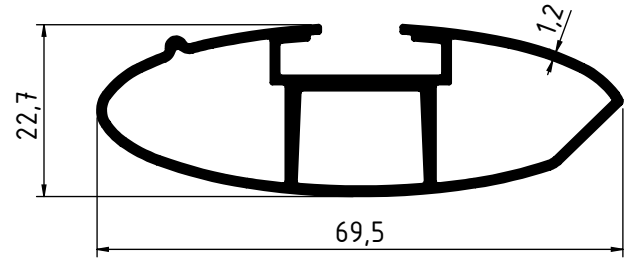

3889 - 0.755 Kg/m

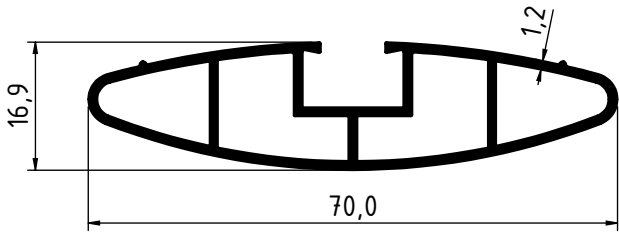

2157 - 0.636 Kg/m

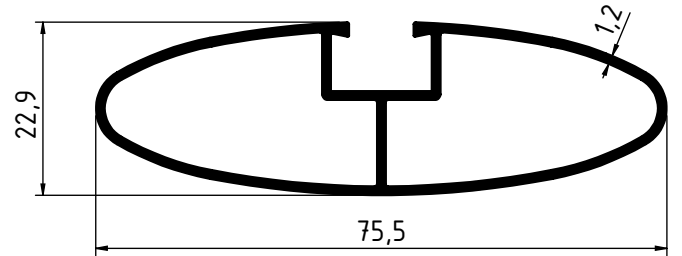

2166 - 0.649 Kg/m

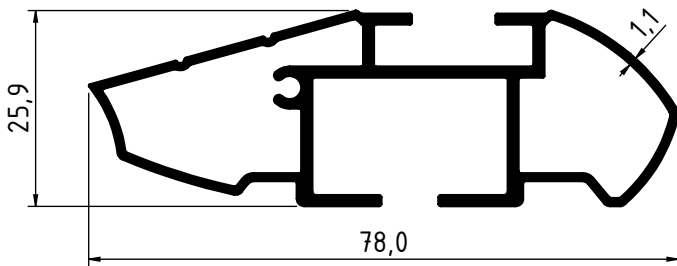

3975 - 0.848 Kg/m



2114 - 0.848 Kg/m

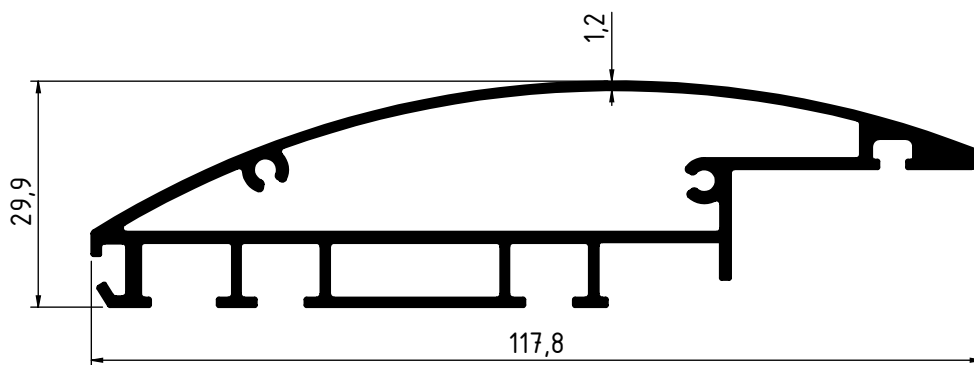

2822 - 1.371 Kg/m

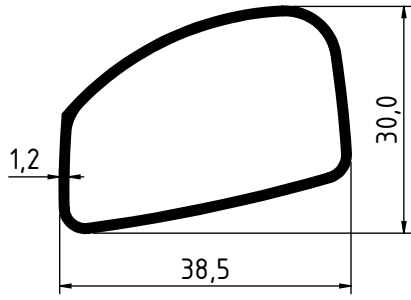

2195 - 0.358 Kg/m

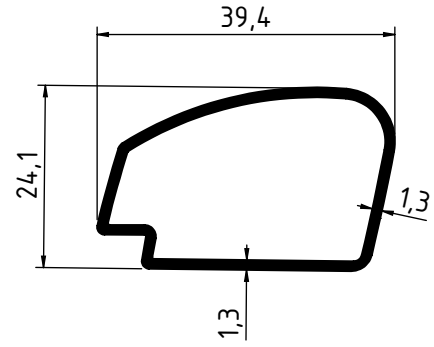

4155 - 0.376 Kg/m

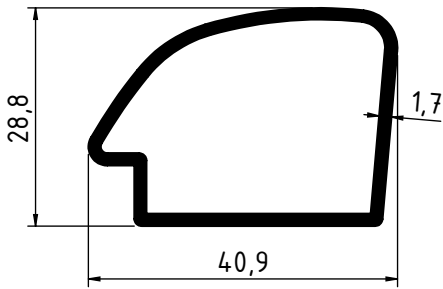

2027 - 0.505 Kg/m

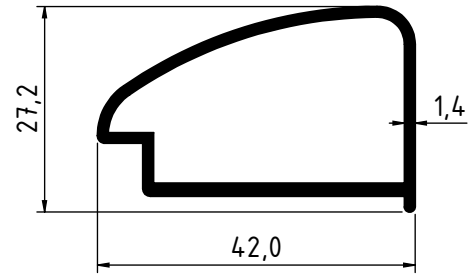

2930 - 0.483 Kg/m

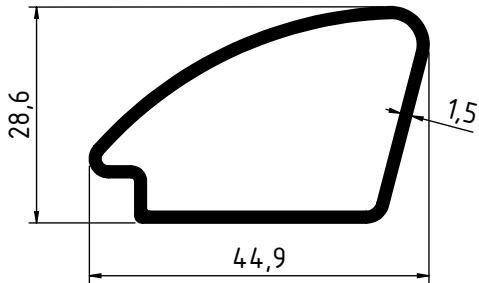

2028 - 0.487 Kg/m

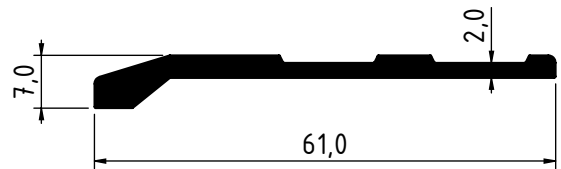

2576 - 0.467 Kg/m

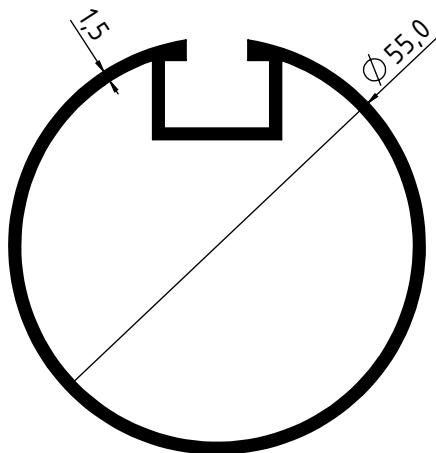

2013 - 0.807 Kg/m

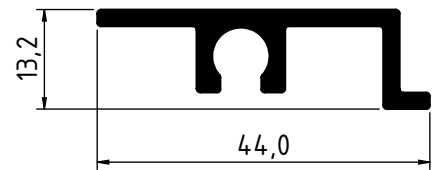

2874 - 0.467 Kg/m

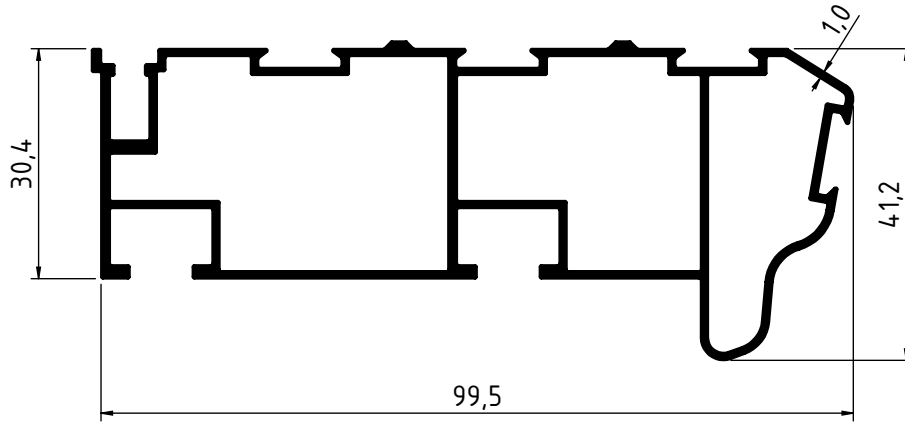

4616 - 1.133 Kg/m

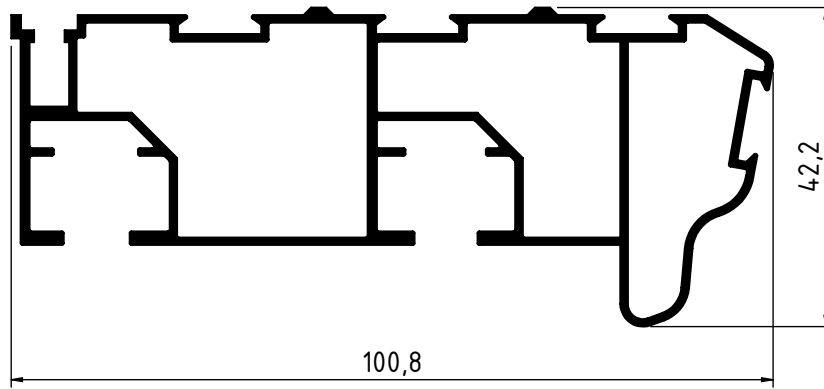

3982 - 1.218 Kg/m

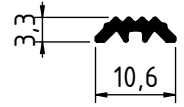

3983 - 0.051 Kg/m

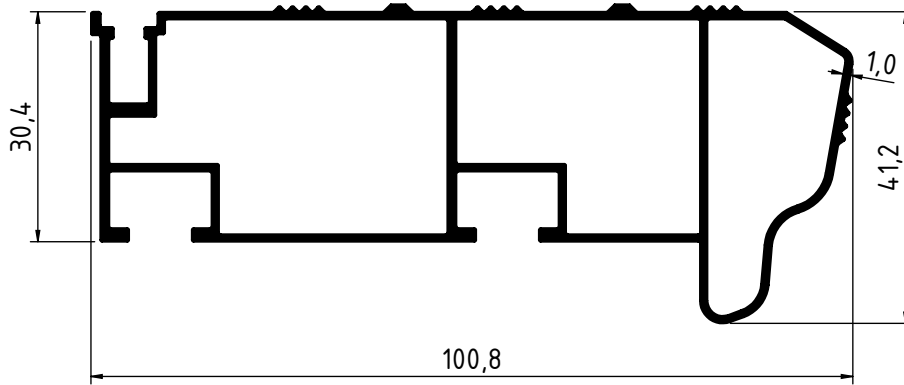

4342 - 1.102 Kg/m

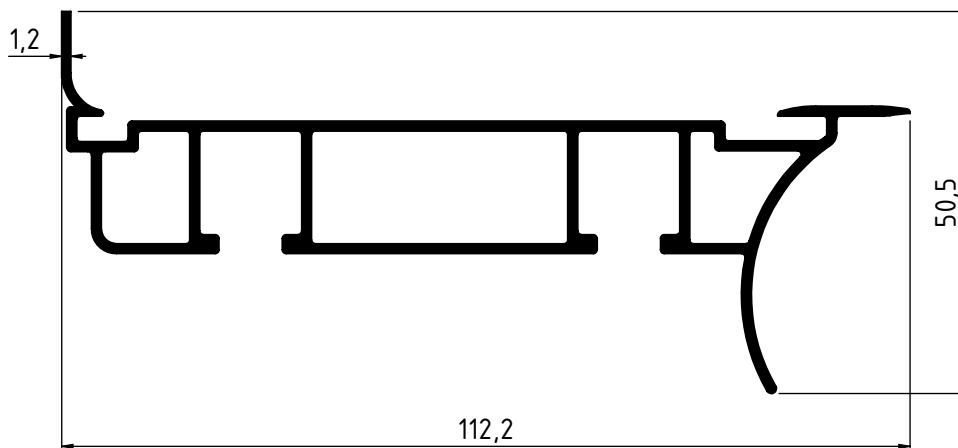

2473 - 1.166 Kg/m

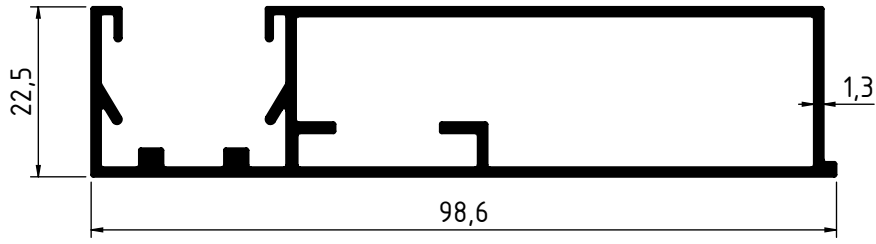

3968 - 0.992 Kg/m

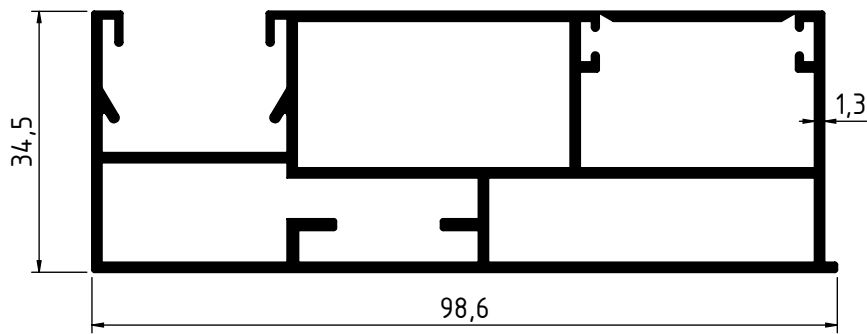

3176 - 1.484 Kg/m

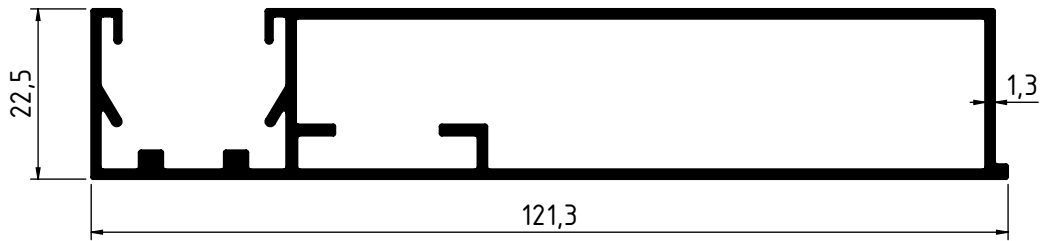

3965 - 1.152 Kg/m

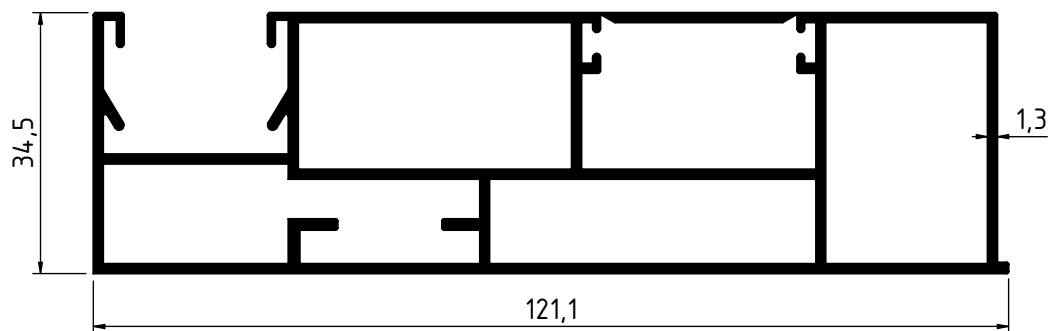

3177 - 1.765 Kg/m

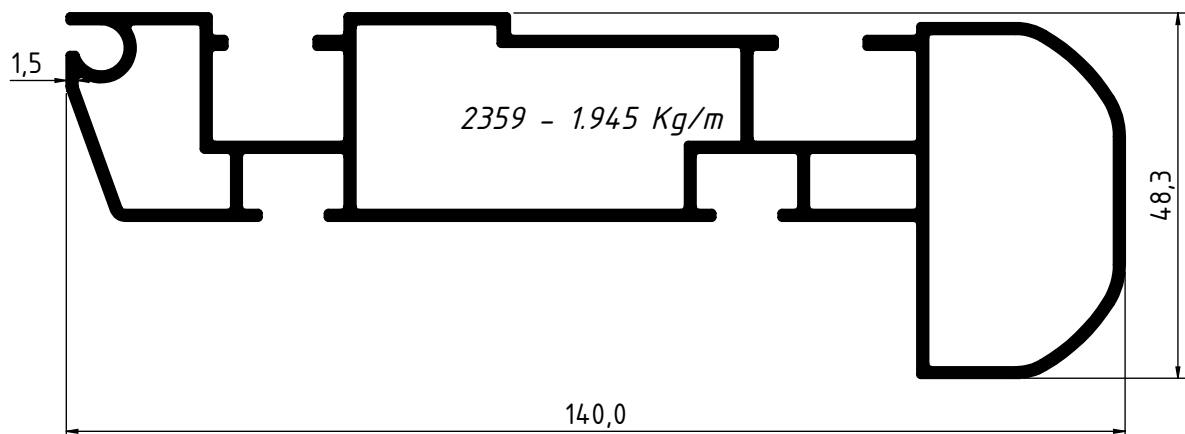
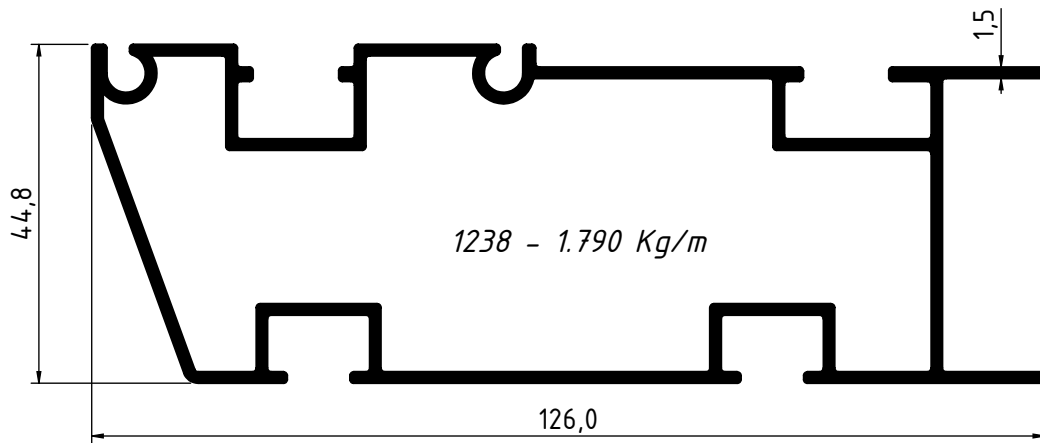
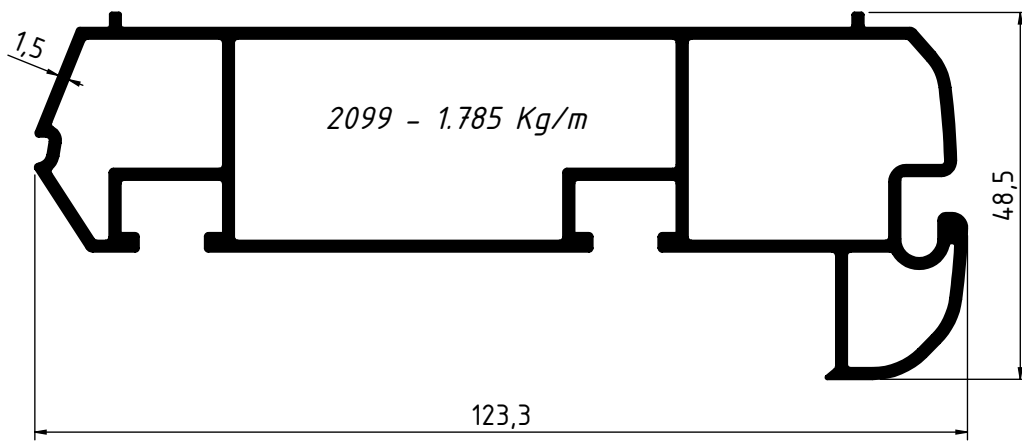
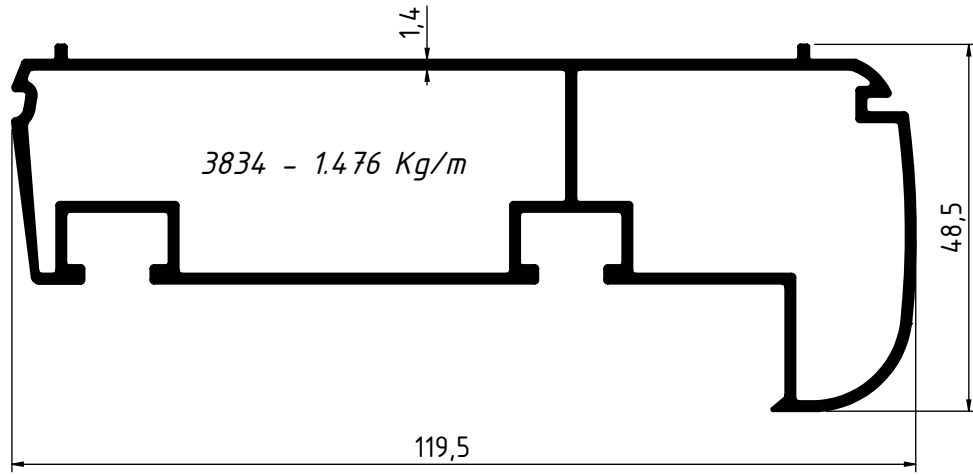

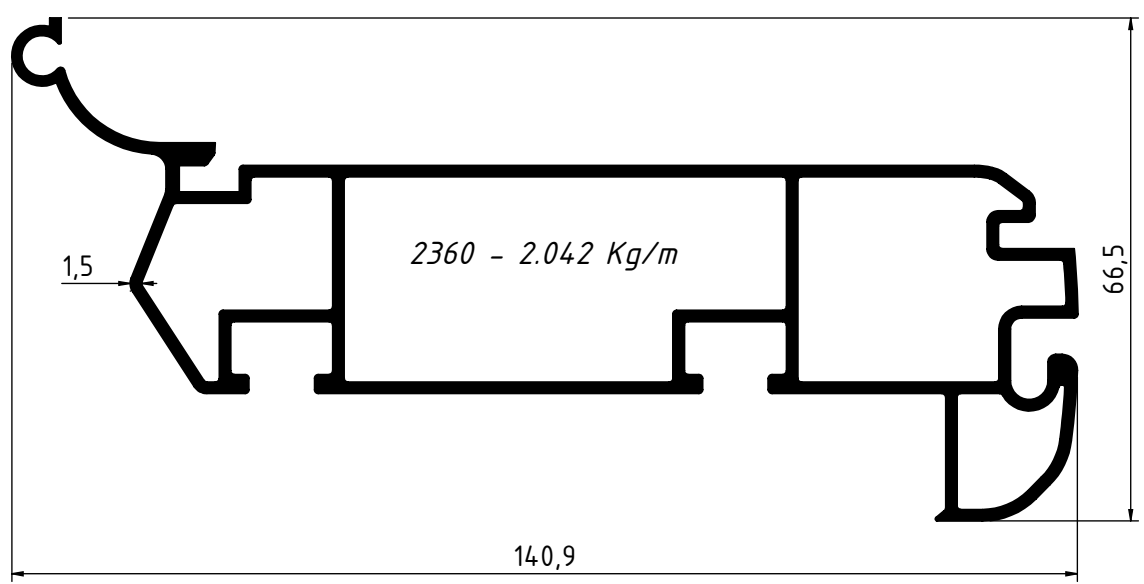
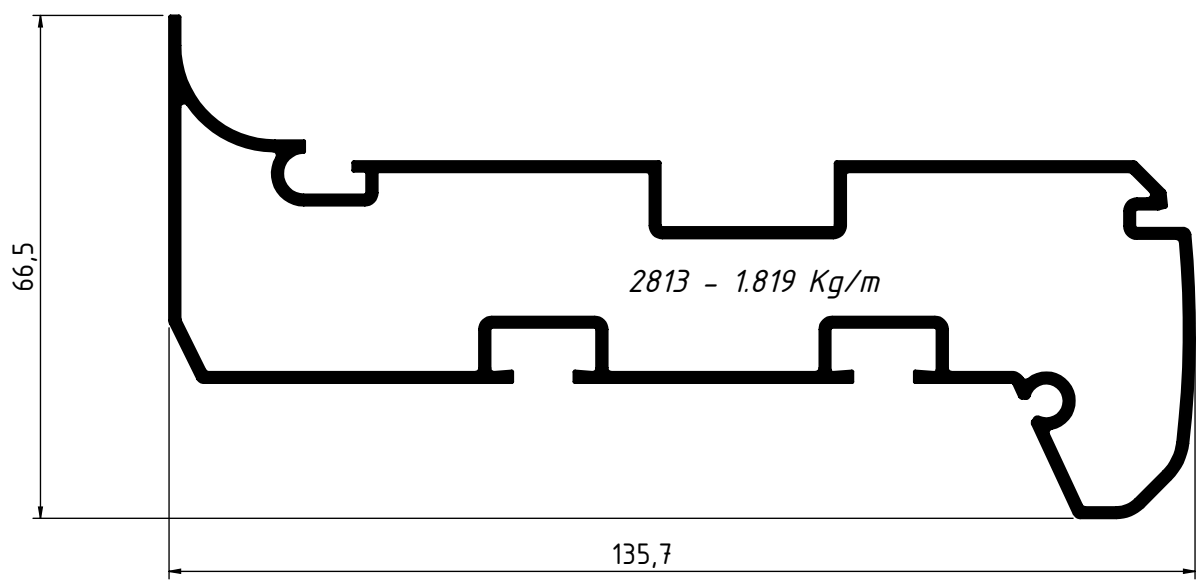
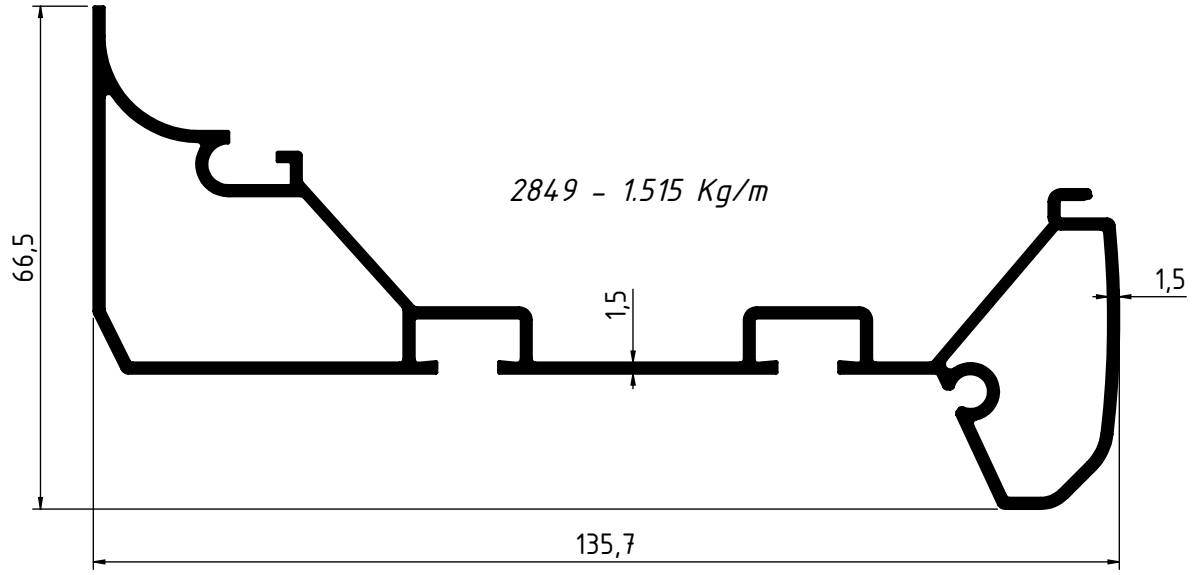

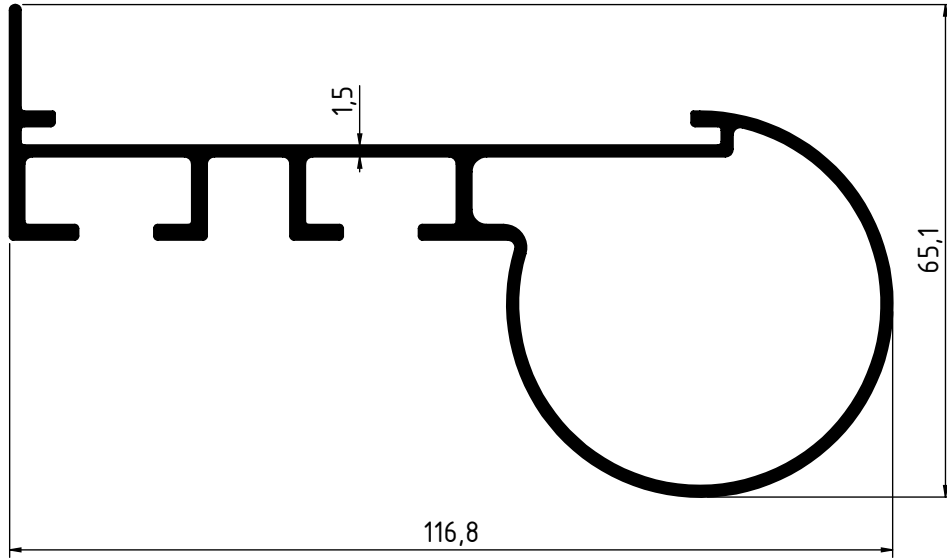

3422 - 1.406 Kg/m

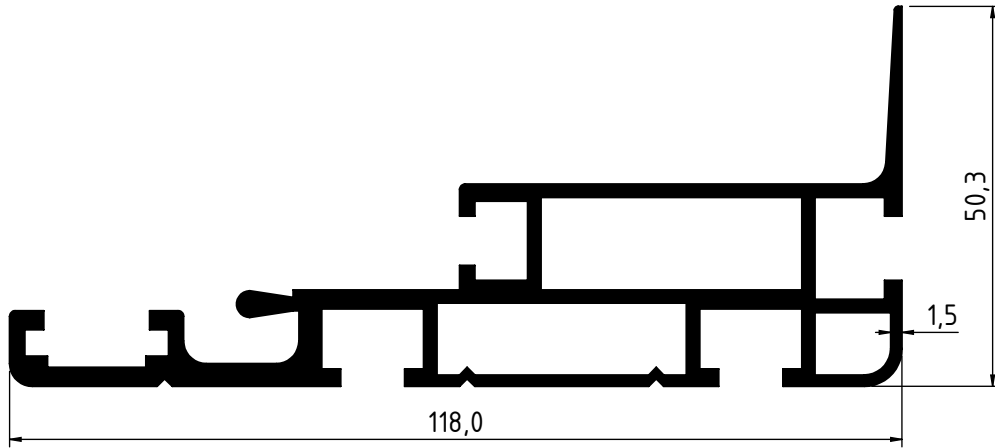

2572 - 2.026 Kg/m

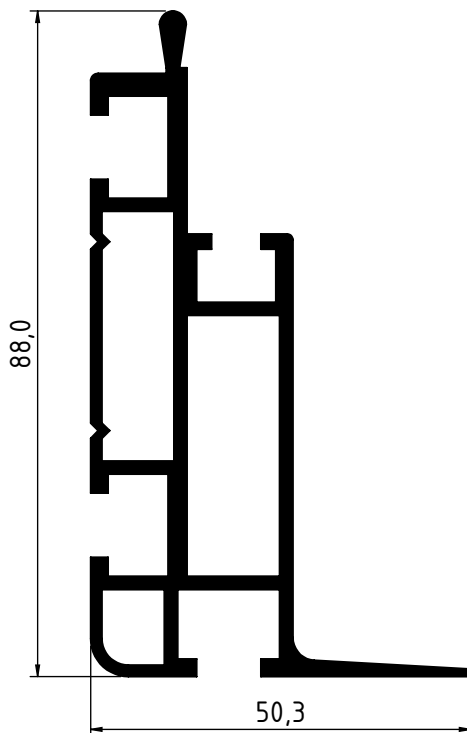

2573 - 1.605 Kg/m

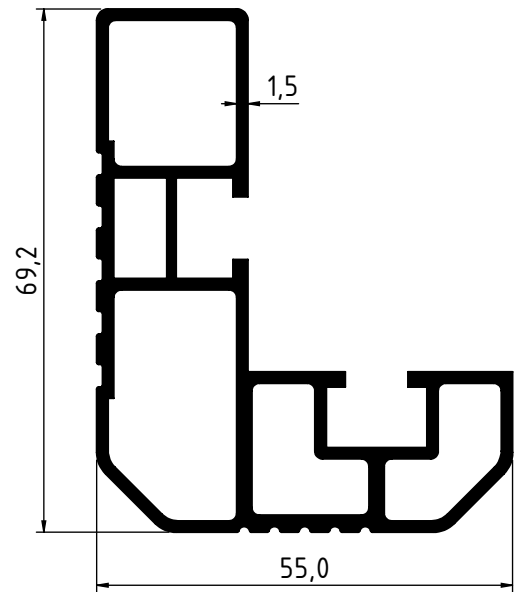

1933 - 1.408 Kg/m

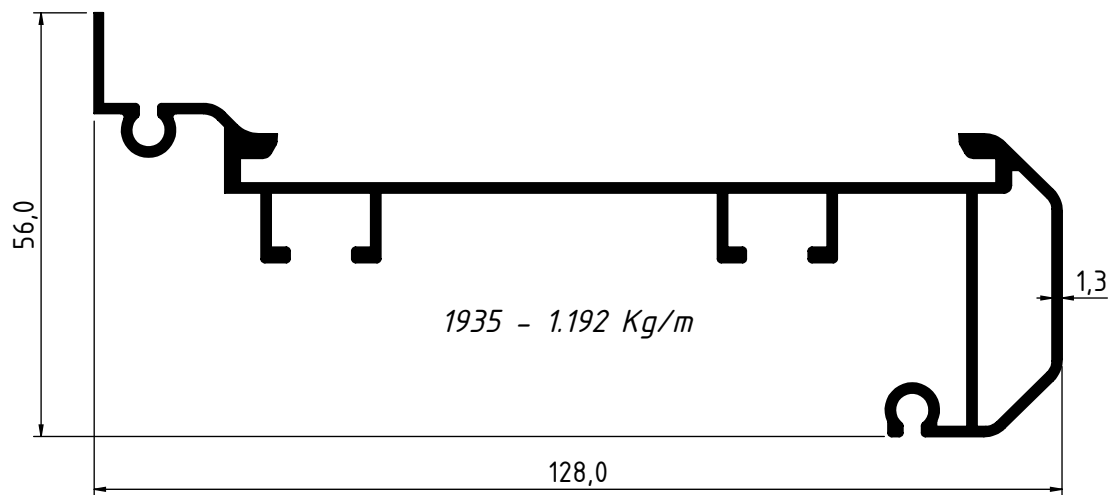
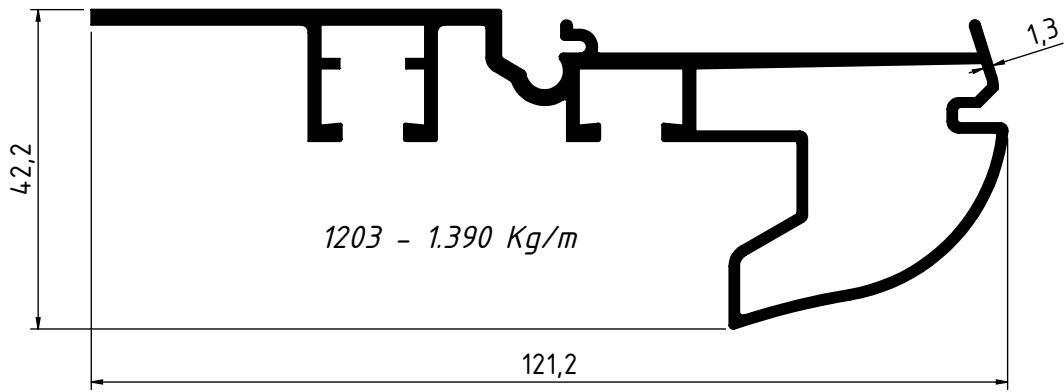
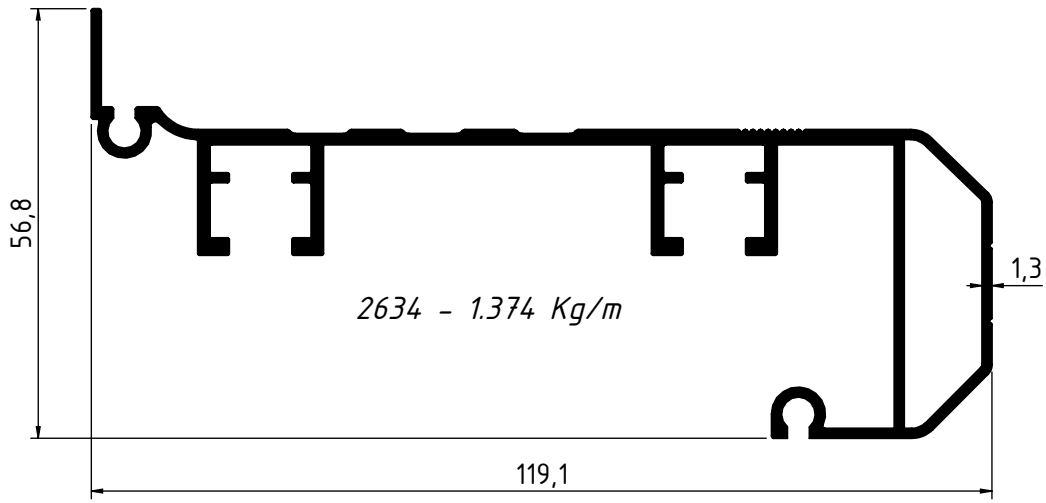
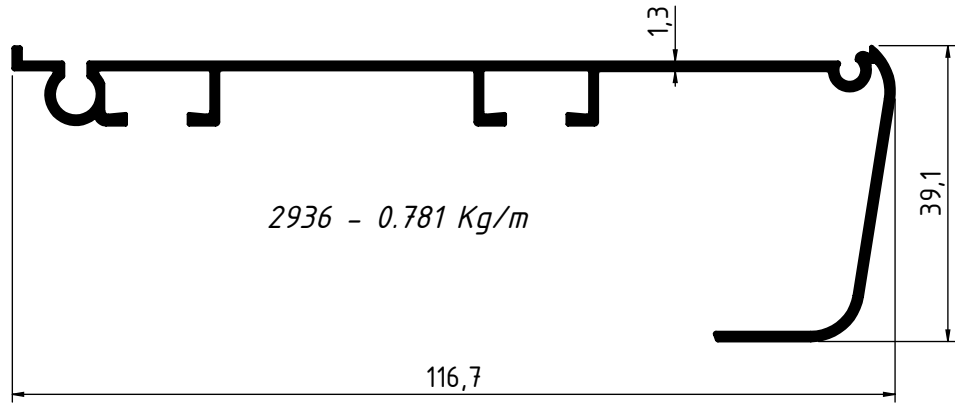

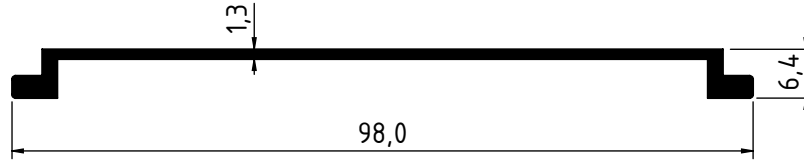

1934 - 0,636 Kg/m

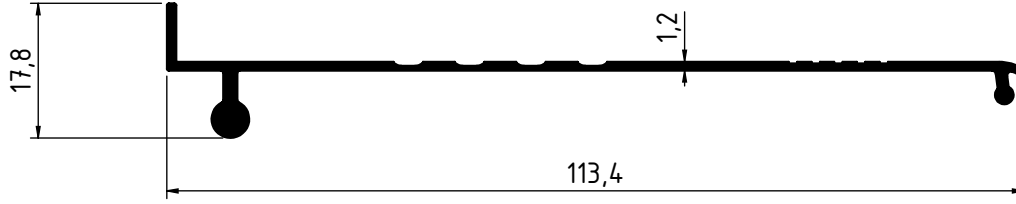

2997 - 0.469 Kg/m

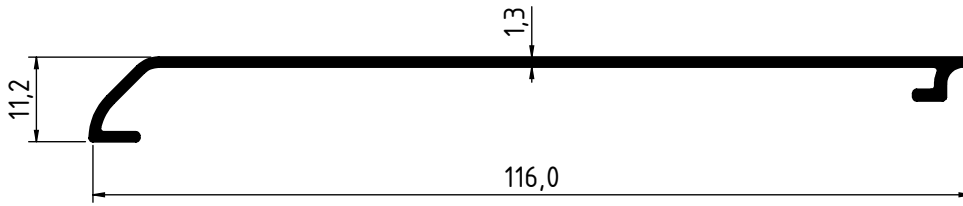

2733 - 0.480 Kg/m

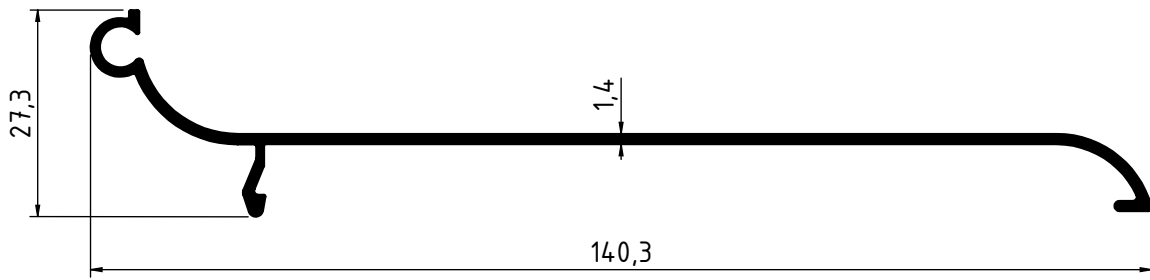

3835 - 0.651 Kg/m

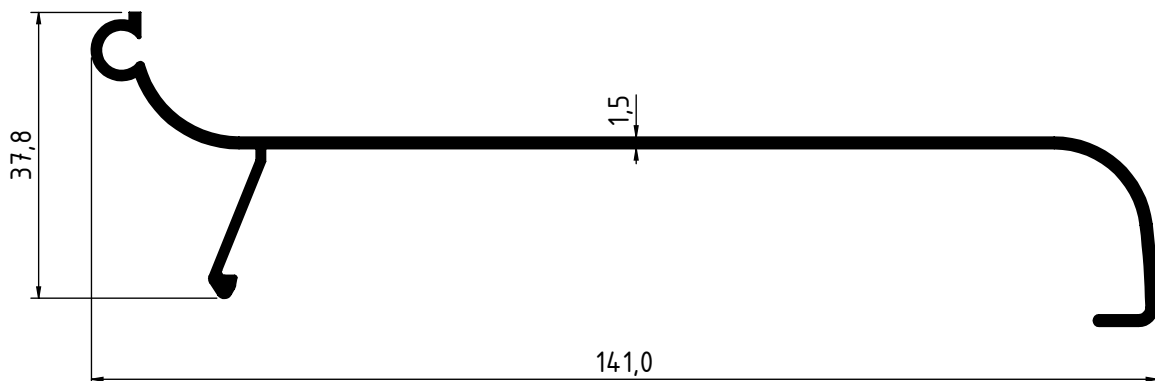

2100 - 0.804 Kg/m

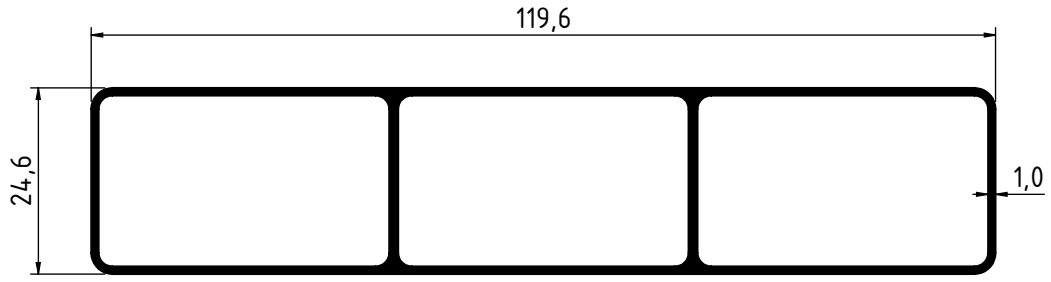

4518 - 0,922 Kg/m

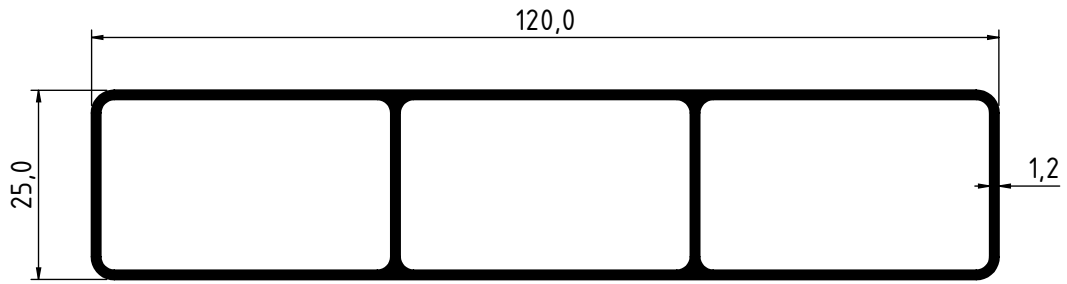

4234 - 1,076 Kg/m

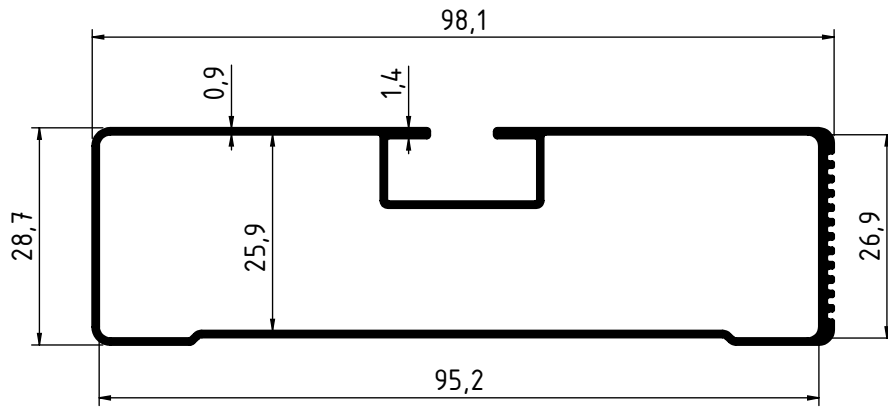

4692 - 0.745 Kg/m

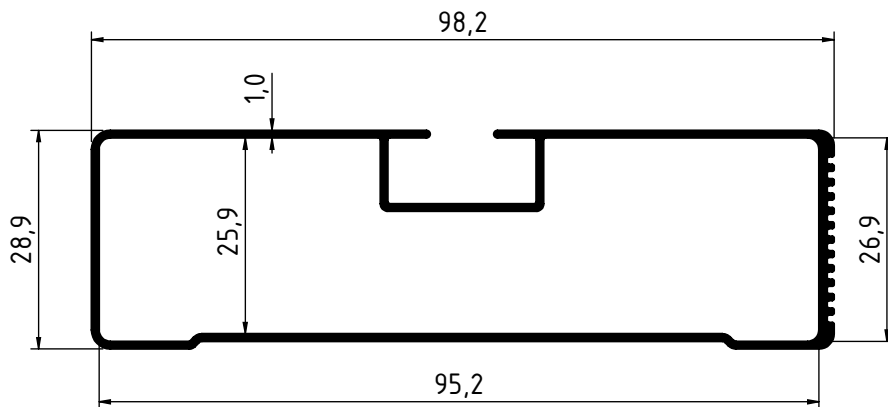

4235 - 0.798 Kg/m

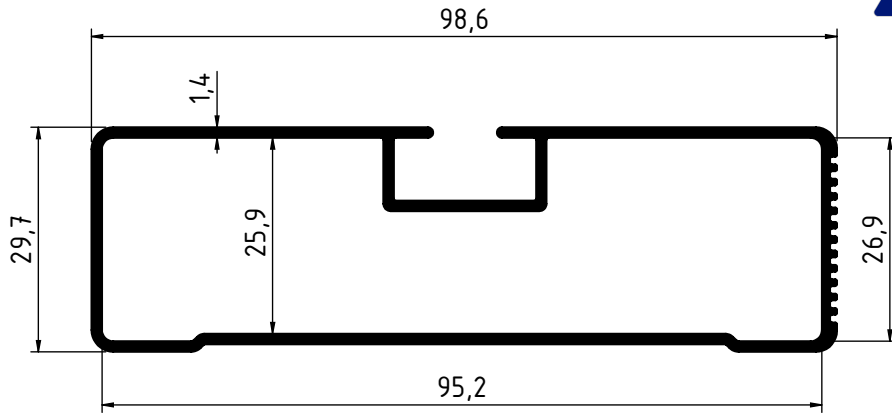

4477 - 1,067 Kg/m

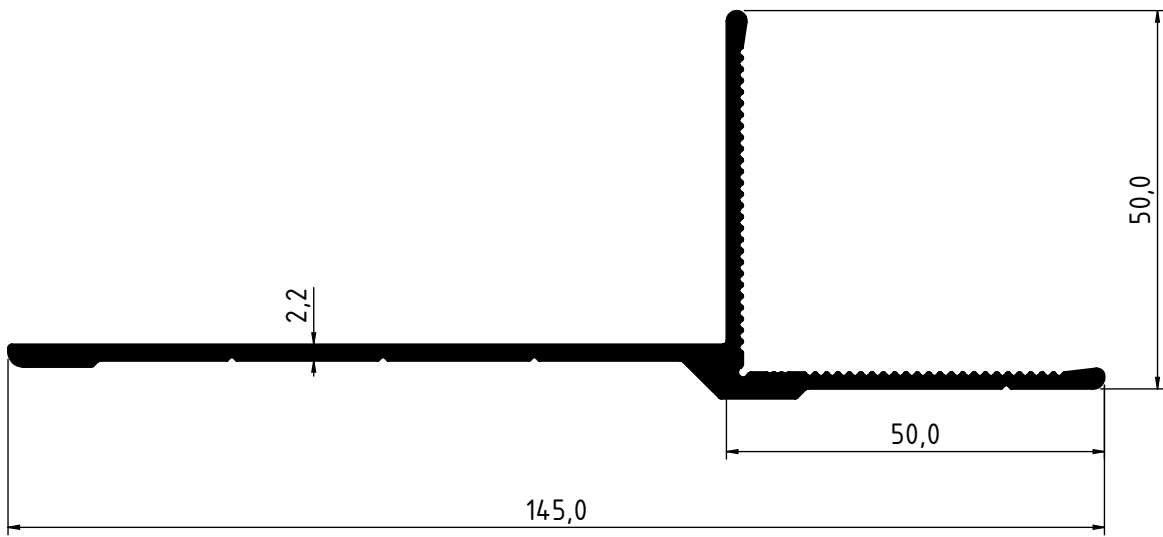

4279 - 1,203 Kg/m

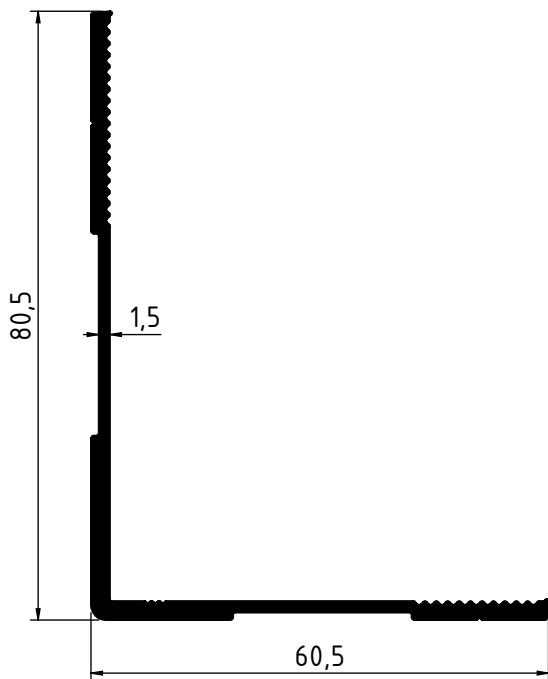

4372 - 0,767 Kg/m

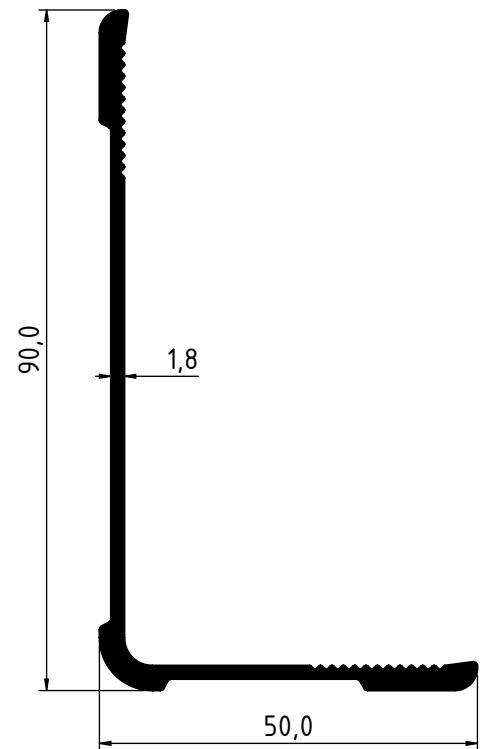

4281 - 0,801 Kg/m

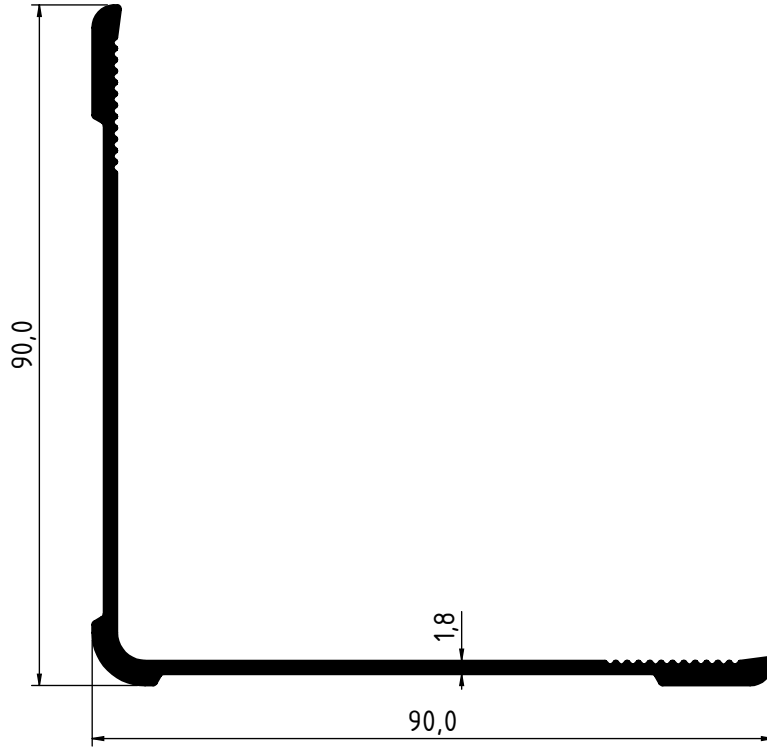

4442 - 0.996 Kg/m

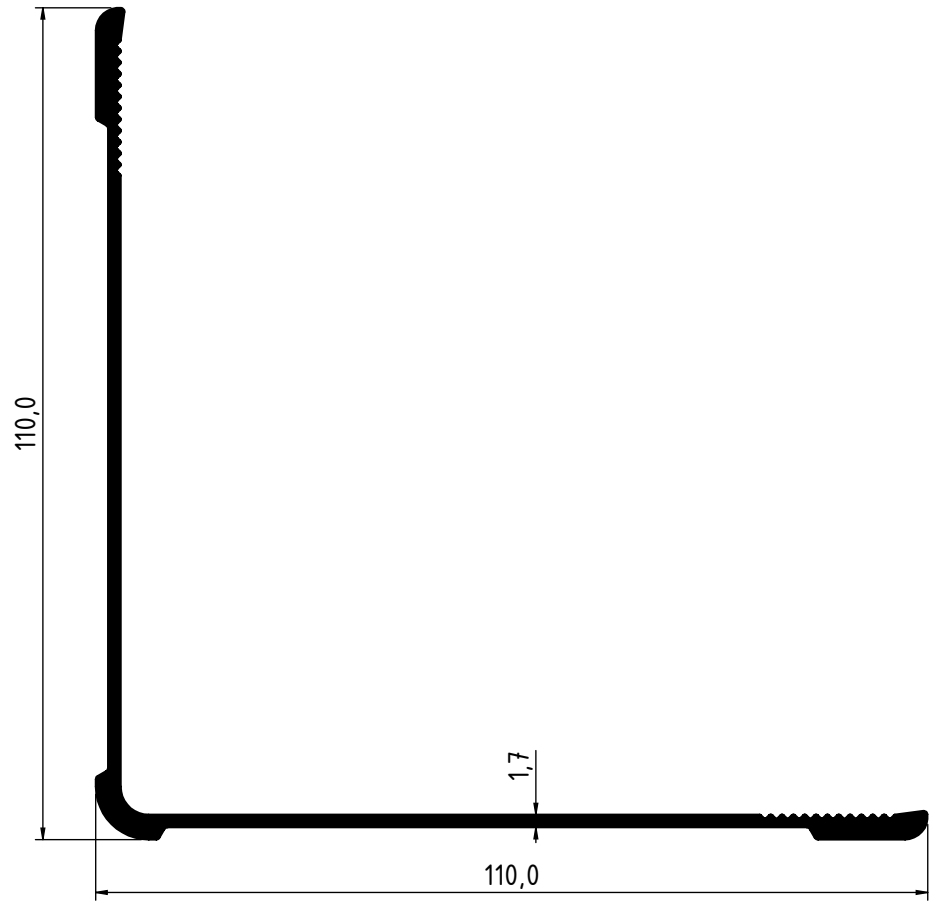

4452 - 1.142 Kg/m

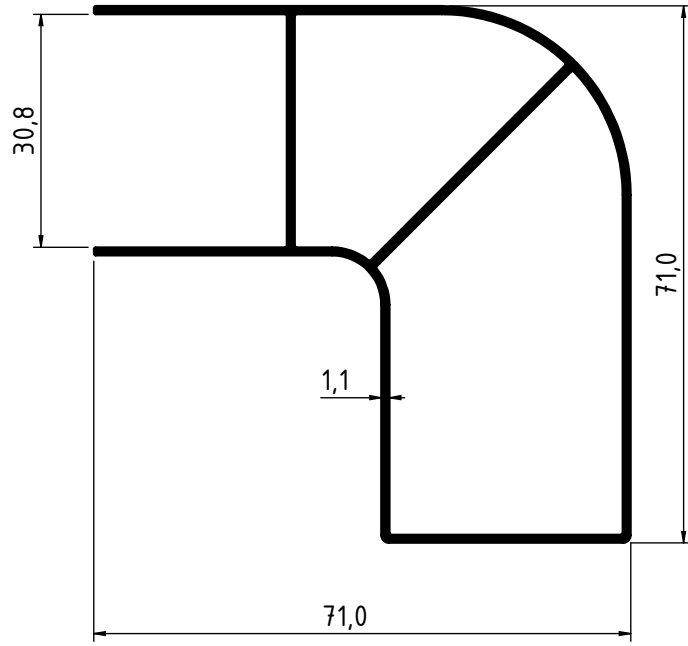

4236 - 0,912 Kg/m

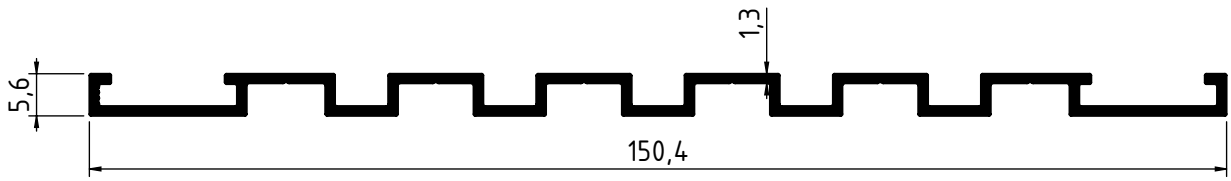

4465 - 0,764 Kg/m

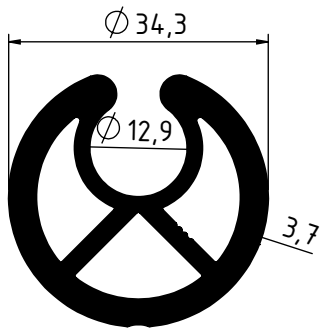

4323 - 1,232 Kg/m

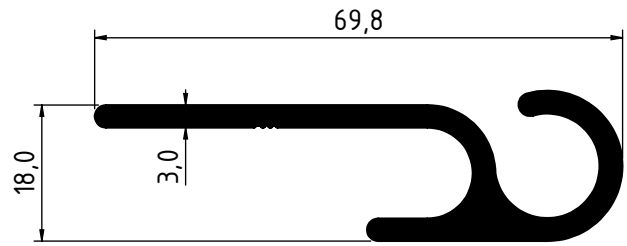

4324 - 0,988 Kg/m

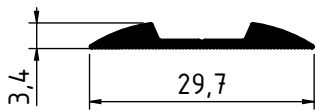

4305 - 0,150 Kg/m

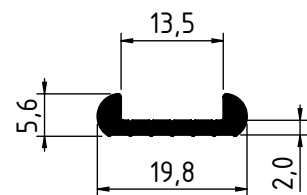

4489 - 0,150 Kg/m